

NBER WORKING PAPER SERIES

TAX RATES AND WORK INCENTIVES
IN THE SOCIAL SECURITY DISABILITY
INSURANCE PROGRAM: CURRENT
LAW AND ALTERNATIVE REFORMS

Hilary Williamson Hoynes
Robert Moffitt

Working Paper 6058

NATIONAL BUREAU OF ECONOMIC RESEARCH
1050 Massachusetts Avenue
Cambridge, MA 02138
June 1997

The authors would like to thank Gary Painter for excellent research assistance and John Bound, Richard Burkhauser, David Stapleton, Finis Welch, and Irvin Rutman for comments. Financial support was received from a National Institute on Aging grant to the National Bureau of Economic Research. This paper is part of NBER's research programs in Aging and Public Economics. Any opinions expressed are those of the authors and not those of the National Bureau of Economic Research.

© 1997 by Hilary Williamson Hoynes and Robert Moffitt. All rights reserved. Short sections of text, not to exceed two paragraphs, may be quoted without explicit permission provided that full credit, including © notice, is given to the source.

Tax Rates and Work Incentives in the Social
Security Disability Insurance Program:
Current Law and Alternative Reforms
Hilary Williamson Hoynes and Robert Moffitt
NBER Working Paper No. 6058
June 1997
JEL Nos. J3, H2
Aging and Public Economics

ABSTRACT

The Social Security Disability Insurance (SSDI) Program has long been criticized by economists for its apparent work disincentives stemming from the imposition of 100-percent tax rates on earnings. However, the program has been modified in recent years to allow recipients to keep some of their earnings for fixed periods of time. Moreover, additional proposals have been made for lowering the tax rate further and for providing various additional financial work incentives. We use the basic labor supply model to show the expected effect of these reforms on work effort. In addition, we provide a numerical simulation that shows the magnitude of the monetary incentives provided by the reforms for different categories of individuals. We find that the proposed reforms have ambiguous effects on work effort and could, contrary to perceived wisdom, possibly reduce work effort and increase the number of SSDI recipients. However, the simulations show that reforms based on earnings subsidies for private employers are more likely to increase work effort and to lower the caseload.

Hilary Williamson Hoynes
Department of Economics
549 Evans Hall
University of California
Berkeley, CA 94720-3880
and NBER
hilary@econ.berkeley.edu

Robert Moffitt
Department of Economics
Johns Hopkins University
Baltimore, MD 21218-2685
and NBER
moffitt@jhu.edu

I. Introduction

Both academic and policy interest in the disabled and in disability programs in the U.S. have increased in the last decade. Public support for greater employment of disabled individuals has increased and has resulted in a major piece of legislation, the Americans with Disabilities Act (1990), encouraging employers to accommodate the disabled. At the same time, the caseloads of many disability programs have been growing, most notably that of the Social Security Disability Insurance (SSDI) program. For example, between 1985 and 1995, the number of disabled workers receiving SSDI increased by over 50 percent. The cause of this increase is still only imperfectly understood but it has generated increased interest in the work disincentives of the program. Added to the general societal trend of an increased expectation that recipients of all welfare programs should work, this has led to considerable discussion of methods by which work levels of the disabled and of disability recipients can be increased.

The SSDI program has long been criticized by economists for its work disincentives. The program has traditionally attempted to make a sharp categorical distinction between those who are "disabled" and therefore not expected to work, and those who are "not disabled" and therefore expected to work. But the definition of "disability" is based not only on the presence of a disabling condition but also on the level of earnings itself; for an individual to be deemed "disabled" requires that earnings be below a fixed threshold (called the 'substantial gainful activity' amount of earnings, or SGA, currently set at \$500 per month). Earnings above this threshold are taken to imply the absence of disability and therefore ineligibility for program benefits, thus resulting in a notch in the budget constraint where the tax rate exceeds 100 percent. Since the program was originally introduced, however, the rules have been relaxed to provide some direct financial incentives; these rules allow recipients to work without penalty for a fixed period of time (i.e., with a tax rate of zero) and permit a second fixed period of time during which tax rates return to 100 percent but recipient eligibility files are kept "open" to allow the recipient to easily come back onto the rolls should their earnings fall. Those rules are still in place but there continue to be additional proposals for greater reductions in work disincentives, either by further reductions in the tax rate or by other means. For example, in the last

year, at least three bills were brought to the floor of the U.S. Congress outlining options for reforming the work incentives of the SSDI program.¹

In this paper we analyze both the rules in the current program that attempt to provide work incentives as well as many features of these recent proposed reforms, both theoretically and empirically. Theoretically, we show the implications for work effort of each rule or reform suggested by the basic economic model of labor supply. Empirically, we report the results of numerical simulations showing how the budget constraint is affected by each of the reforms--that is, how take-home income is affected at different levels of hours of work--for different types of individuals. Although we do not provide simulations of actual changes in work effort, because that would require information on income and substitution elasticities which are not available from the literature, our simulations nevertheless show that, surprisingly, the financial incentives implied by some of the reforms are not as strong as expected and may even be in the wrong direction. However, we also provide simulations of the effects of a different type of reform--earnings subsidies--which have quite different, and more favorable, effects.

The outline of the paper is as follows. In Section II, we discuss the rules of the SSDI program governing eligibility and benefits, with a focus on those related to work incentives. We analyze the expected labor supply effects of those rules, and what the existing literature has to say about their magnitudes, in Section III, and also provide numerical simulations of the magnitudes of the financial incentives. In Section IV we discuss the expected effects of various reforms and show their simulated financial incentives. We draw our conclusions in Section V.

II. Eligibility and Benefits of SSDI

The SSDI (henceforth simply 'DI') program is part of the Old-Age, Survivors, and Disability

¹These bills include the *Work Incentive and Self Sufficiency Act* of 1996 (Senator Jeffords), the *Rehabilitation and Return to Work Opportunity Act* of 1996 (Representative Bunning) and the *Transition to Work Act* of 1997 (Representative Kennelly).

Insurance (OASDI), or Social Security, program. Disability benefits were added to the retirement program in 1957 and are designed to provide partial earnings replacement to all workers under 65 who sustain severe, long-term (typically career ending) disabilities.² All workers covered under Social Security (about 95 percent of the U.S. work force) are also covered for DI benefits and financing for the program comes out of employer and employee paid FICA taxes. In 1995, the DI program provided benefits for about 4.2 million disabled, non-aged individuals and their families for a total cost of 40.9 billion dollars (U.S. House of Representatives, 1996).

Throughout the program's history, the determination of an individual's disability status has depended on an assessment of ability to work. Specifically, disability is defined as "the inability to engage in any substantial gainful activity by reason of medically determinable physical or mental impairment which can be expected to result in death or which has lasted or can be expected to last for a continuous period of not less than twelve months" (Social Security Administration, 1992). Therefore a medical definition of disability is not sufficient for benefit receipt. Instead, initial and continuing eligibility is tied to the ability to work. Substantial gainful activity (SGA) is defined as a threshold level of earnings, which is currently set at \$500 per month.³

In addition to meeting the definition of disability, initial eligibility for DI requires having sufficient work history in jobs covered by Social Security.⁴ The DI benefit is equal to 100 percent of the worker's primary insurance amount (PIA), which is a function of the individual's earnings history in Social Security

²Other programs for the disabled include the Supplemental Security Income (SSI) program, several veteran's compensation programs, worker's compensation, and state-provided temporary disability benefits.

³The SGA is not indexed for price changes and has been increased nine times in the program's 35 years. The SGA started in 1957 at \$100, and was \$300 from 1980-1990 before the latest increase to \$500. A deduction is allowed for impairment-related work expenses.

⁴Applicants must have worked 20 of the last 40 quarters preceding the quarter of application, although the rules differ somewhat for younger workers. The work history required for DI is virtually the same as that required for social security retirement benefits.

covered employment.⁵ This benefit can be significant in size, and is typically equal to the full value of the worker's potential Social Security retirement benefit. In 1993, DI benefits for disabled workers averaged \$642 per month. The PIA calculation is based on a progressive structure under which high wage workers obtain lower earnings replacement rates than lower wage workers. The replacement rate in 1994 ranges from 78 percent for workers with low average monthly earnings (\$500) to 29 percent among workers with high monthly earnings (\$4500) (U.S. House of Representatives 1994).⁶

Current law allows recipients pass through up to three different phases of DI receipt. First, there is a five month waiting period after disability begins before benefits can be received (although there is no waiting period if the individual returns to the rolls within 5 years of leaving). If the recipient never works thereafter, the subsequent phases are never entered. Second, a trial work period (TWP) allows for up to nine months of work over a 60-month calendar period. A month is counted as a trial month (and therefore toward the limit of nine months) if the individual earns over \$200 in the month.⁷ During the TWP, benefits are provided in full regardless of the level of earned or unearned income. This phase, referred to in the Introduction, relaxes the strict application of the SGA rule and was introduced in 1960 in order to let recipients test their ability to work without danger of losing benefits. Third, individuals who accumulate nine months of work in the TWP have their case reviewed; if the work is judged to not be "SGA" (generally meaning that it reflects an ability to earn more than the SGA monthly threshold), they are allowed to continue on the rolls as before with the requirement to stay below SGA to retain eligibility. But if the work in which they have been engaged is "SGA", benefits are provided in full for a subsequent grace period lasting three months and then a 36-month

⁵The benefit can be as large as 150 percent of PIA for disabled workers with families.

⁶The earnings figures refer to the worker's average indexed monthly earnings (AIME) in social security employment. The DI benefit, equal to the worker's PIA, is a function of the AIME. Benefits are adjusted for changes in the cost of living. The PIA and AIME are calculated in roughly the same way as they are for social security retirement benefits.

⁷The earnings limit was set at \$50 for much of the history of the program until it was recently increased to \$200. It is intentionally set at a low level in order to trigger review of recipients who enter work at any level.

period follows called the extended period of eligibility (EPE).⁸ During this period, benefits are provided in full if earnings (net of allowed deductions) are less than SGA, but are reduced to zero if earnings are over SGA. Thus a strict SGA rule is applied, but the recipient's file is kept open and eligibility does not have to be completely reestablished if earnings fall below SGA. This rule is designed to allow recipients who do not succeed in maintaining a steady flow of above-SGA earnings to receive benefit support quickly and easily. After the EPE is exhausted, the individual is dropped from the rolls if he has achieved SGA more or less continually. If the individual has achieved SGA only part of the time, he must file a new application to show that he is still disabled. If he has never achieved SGA (despite having exceeded it during the TWP), the EPE is extended indefinitely but as soon as he achieves SGA, he is dropped from the rolls. The EPE, which is designed to provide insurance to the recipient should he continue to try to establish himself in the private labor market with steady earnings, was introduced in 1980.⁹

This structure leads to a complicated sequence of marginal tax rates over time. An increase in earnings will increase income but it may be offset by reductions in transfer benefits and other taxes. During the TWP, for example, the marginal tax rate (MTR) is zero implying that there is no change in benefits in response to a change in earnings or hours. During the EPE, the SGA rule is reintroduced and the MTR is zero for earnings changes below SGA but exceeds 100 percent for earnings increases that exceed SGA, thus creating a "notch." However, the EPE is best thought of as part of the TWP and, as we will show below, the more relevant calculation is the MTR on the combined TWP and EPE periods.

III. Effects of DI on Labor Supply

⁸The three month grace period is considered part of the 36 month EPE.

⁹Medicare benefits are provided to DI recipients after a two year waiting period. Once the individual enters the EPE, Medicare benefits are available for the next 39 months. Thus Medicare is provided for a three months past the end of EPE. The availability of Medicare benefits may add substantially to the "insurance" value of DI which is discussed in the text. Once a worker reaches age 65, the DI case is automatically transferred to the social security retirement system.

A. Expected Effects of Work Incentive Provisions

The DI program is designed to replace (or supplement) earnings for workers who are unable to engage in "substantial gainful activity." However, as long as individuals with a disabling condition can alter their earnings by exerting different amounts of effort, the program will have work disincentives, just like all income-conditioned transfer programs, because it will induce some individuals to go onto DI rather than work. It is generally thought that these work disincentives can be reduced, though not eliminated, by low tax rates, and hence the high MTR in the DI program may create larger work disincentives than are necessary.

The framework within which work incentives of transfer program tax rates are generally analyzed is the conventional labor-leisure model. That model uses the assumption of utility maximization to justify the common-sense presumption that individuals trade off the amount of take-home income they would have for different levels of hours of work with the desire for and difficulty involved in that work. As an empirical matter, the model implies that the choice of how much to work is based partially upon how much take-home income is gained by working various amounts--or by how much is gained by working less, in the case of some transfer programs.

To apply the model, consider a population of disabled individuals eligible for the DI program.¹⁰ Let us also initially consider each of the DI phases as if work choices were made separately within each. Later we consider the combined effects of the phases of program. In the first phase, the individual decides whether to go onto the rolls by applying for DI. Earnings must necessarily be low during the application and waiting periods which will lead to lower work effort.¹¹ Second, during the TWP, benefits are received in full regardless of earnings and the MTR is zero. DI benefits therefore generate a simple income effect, which

¹⁰ We assume that the individuals know with complete certainty whether they would qualify were they to apply and hence we ignore the uncertainty about eligibility which has been heavily discussed in the literature (e.g., Bound (1989); Halpern and Hausman, (1986)).

¹¹We of course are implicitly referring to averages in the population. Some portion of the eligible population would not work even in the absence of DI, and for them there is no reduction in labor supply.

reduces labor supply assuming leisure is a normal good. Third, during the EPE, the labor supply effects illustrated in Figure 1 are generated. The budget constraint ADE (slope equal to the hourly wage rate) applies in the absence of the DI program, whereas ABCDE applies during the EPE; the benefit amount is AB, the SGA level of earnings is noted on the vertical axis, and the notch at point C is where eligibility ends. The MTR is over 100 percent at this point. This is also the budget constraint for what might be termed a "strict" SGA program, with no EPE and no TWP--that is, the constraint that applied before those programs were introduced. A negative income effect, illustrated by arrow 1, plus a substitution effect generated by reductions in labor supply to obtain benefits, illustrated by arrow 2, both lower labor supply.

Instead of examining effects relative to no program at all, as this discussion does, one may also examine the effects of introducing the TWP and EPE into a program with only the strict SGA. As shown in Figure 2, introducing the TWP into a strict SGA program extends the budget constraint BC up to E, as illustrated by the dotted line, during the TWP period. However, while this induces some individuals to work more, as illustrated by arrow 1, it lowers labor supply for others, as illustrated by arrow 2. The latter effect would occur if some individuals come onto DI after the TWP is introduced and thus represents what is sometimes called a program "entry" effect. More accurately, an individual initially working above SGA off the rolls would come onto DI to take advantage of the TWP if the advantage of the nine months of TWP benefits outweighs the loss of benefits during the eligibility and waiting periods; thus it is the relative advantage of the combined period that is relevant (as our calculations below will show). This makes the effect of the TWP on labor supply ambiguous in sign, contrary to the presumption among policy-makers that it would unambiguously increase labor supply. If the work-increasing effect were small enough, and the entry effect were large enough, average labor supply could fall. It is also clear from the diagram that the DI caseload would unambiguously rise, at least on average, since the entry effect increases the caseload while the work-increasing effect does not affect it.

The ambiguous effect of the TWP on labor supply is closely analogous to an ambiguous labor-

supply effect of lower marginal tax rates in the Aid to Families with Dependent Children (AFDC) program, the negative income tax, and other transfer programs (Levy, 1979; Moffitt, 1992). In those programs, a reduction in the MTR raises the "break-even" level and draws some individuals onto the rolls, thereby partially or fully offsetting whatever labor-supply-increasing effects arise from an increase in work effort among individuals initially on the rolls.

The introduction of the EPE by itself has no effect in the simple labor supply model if a strict SGA program is already in place since it is equivalent in that model to a strict SGA. To permit it to have an effect, the model would have to be modified in one of two ways. First, a fixed cost of applying for benefits could be introduced. Such a fixed cost would be incurred on initial application to DI but would not be incurred during the EPE, since the DI program keeps individual files "open" during that period even if they work above SGA and allows them to receive benefits if their earnings fall below SGA without having to go through the process of reestablishing eligibility. Second, uncertainty could be introduced into the model and the EPE could be modeled as a form of insurance, treating benefits as a source of income that is available if negative shocks to earnings are received. However, this effect by itself would not have special relevance to the EPE without the fixed costs argument, for, in the absence of fixed costs--that is, costs of establishing eligibility--an individual could establish even initial eligibility instantly and hence the DI program as a whole would function more purely as short-term insurance.

A modified model which included fixed costs and, possibly, uncertainty, would show the EPE to have ambiguous effects on labor supply just as the TWP has. This is because, relative to a program without the EPE, the implicit benefit of being on DI is increased, either because certain fixed costs no longer have to be incurred or because an implicit value (insurance) is added. This would lead some individuals who would have chosen to stay off DI altogether and to work above SGA to go onto DI and work while on it at lowered hours, thereby reducing labor supply and increasing the caseload. As before, this could partially or fully offset the work-increasing effect coming from those who, in the absence of EPE, would have worked below

SGA or not at all while on the rolls.

Finally, it is worth noting that while the ambiguous effects of the TWP and the EPE on average labor supply have been discussed in terms of possible offsetting entry effects, offsetting effects could also show up, statistically, in the program exit rate. Exit from the DI rolls occurs naturally over time as individuals' opportunities off the rolls fluctuate and sometimes improve. The TWP and EPE alter an individual's incentive to take advantage of those opportunities and to leave the rolls. Introducing the TWP can be expected to reduce the exit rate during the TWP period because benefits are now higher than they were under strict SGA; and the EPE can be expected to reduce the exit rate during the EPE period as individuals are more reluctant to leave the rolls because they will have to incur fixed costs of reestablishing eligibility, should they wish to come back on, and will lose the implicit insurance value. Since labor supply off the rolls is higher than on the rolls, labor supply is reduced in both cases by the fall in the exit rate. Thus the offsetting factors from introducing the TWP and EPE, if they are present, may show up in both increased entry to, and decreased exit from, the program. We shall simulate numerically the amounts by which the TWP and EPE increase the income gains from entry and increase the income losses from exit below.

B. Evaluating Work Incentive Provisions Using Existing Research

To evaluate the work incentive provisions of the DI program, we need to know the sensitivity of recipient work effort to changes in net wages (or MTRs) and in income opportunities. To estimate the magnitudes of possible entry and exit effects, we also need to know how potentially eligible individuals respond to changes in MTRs and benefit levels and how recipient exit decisions respond to those variables. Unfortunately, the existing empirical research does not provide estimates of the substitution and income effects needed to make these calculations.

Many empirical studies have examined the effect of DI benefits level on program participation (or

caseload size).¹² Participation in DI is typically estimated as a function of the potential DI benefit --imputed for those not on the program-- and individual characteristics such as age and education, and locational characteristics. The main parameter of interest, the elasticity of DI participation with respect to the DI benefit, varies widely in the literature, ranging from 0.06 to 1.80.

These results, while important for some applications, fall significantly short of what is needed to estimate the effect of the TWP, the EPE, or proposed changes to these work incentive provisions. In the absence of direct evaluations of the TWP, for example, inferences about its effects could be made only by estimating the number of individuals who would prefer to work above SGA but still receive benefits; and wage elasticities as well as income elasticities are needed for this prediction. The marked absence of attempts at estimated wage elasticities is, in fact, the major defect of this literature for assessing the effectiveness of work incentive provisions.¹³ Furthermore, in these studies, participation in DI is considered equivalent to non-participation in the labor market. This rules out examining the sort of responses shown by the arrows on Figures 1 and 2.

C. Income, Earnings and Tax Rates Under Current Law: Simulations

Although the existing DI literature does not permit us to make reliable predictions for the net work effort and caseload effects of the work incentive provisions, we can obtain some notion of the incentives to work and take-up DI benefits by calculating the income gain or loss associated with different work effort levels and program participation statuses, and the implicit tax rates that result. We shall therefore provide

¹²This literature is critically reviewed in Leonard (1986) and Hoynes and Moffitt (1996), and the exchanges between Parsons (1984) and Haveman and Wolfe (1984) and Parsons (1991) and Bound (1991).

¹³Some of the studies (e.g., Parsons 1980a and 1980b) do include wages but only their pre-disability level, and only in the form of a replacement rate, which results in neither an income nor a wage elasticity. Obtaining estimates of wage and income elasticities for DI recipients is difficult. For example, the DI benefit itself is endogenous due to its relationship to previous work experience. Furthermore, DI receipt is uncertain, and it is difficult to impute DI benefits for non-recipients. These issues and their relevance for the empirical literature are discussed in Leonard (1986), Haveman and Wolfe (1984), and Bound (1991).

numerical simulations of those variables for individuals with different benefit and wage levels. However, the preceding analysis has made clear that individual decisions are no doubt made not within each phase alone, but taking into account all phases together. Therefore we shall be most interested not in the monthly MTRs within, say, the TWP or the EPE, but rather the implicit MTR which applies to an entire sequence of labor supply values over all phases of DI receipt. This will become clearer momentarily.

To begin our simulation, we consider an individual at the time of onset of disability. The disabled individual is assumed to be out of labor force for 12 months--5 months for the waiting period and 7 more months for "recuperation"--before the option of reentering the workforce is possible. We then consider the consequences of entering the workforce at some specific level of work. We consider five work level alternatives: no work, 10 hours per week, 15 hours week, 20 hours per week or 40 hours per week. To simplify the calculations, we assume, for our initial simulations, that the recipient continues with this level of work effort indefinitely.

We consider a recipient's time horizon over a period of 57 months, representing the minimum time an individual would need to complete all phases of DI receipt, all the way to the end of the EPE.¹⁴ In each month, we calculate a recipient's earnings and DI benefit given the program rules, his wage, work effort, and benefit level. We consider the wage and benefit levels associated with three types of workers. "Low wage" workers are those who worked at the federal minimum wage for their entire work history; "medium wage" workers have earned the average wage over their career; and "high wage" workers have earned 150 percent of the average wage for their career. Each of these three types of workers is assigned the appropriate DI benefit

¹⁴The 57 month horizon is the sum of the 5 month waiting period, 7 months of recuperation, 9 months of TWP, and 36 months of EPE. This time horizon could be extended but would not change the nature of the tradeoffs we illustrate. Because we assume that individuals enter the work force after 12 months of recuperation, our DI recipients receive benefits for a minimum of 19 months (7 months of recuperation, 9 months of TWP, 3 month grace period) and are out of the labor force for a minimum of 24 months (includes 5 month waiting period before benefit receipt).

that results from this work history.¹⁵ Further we assume that the onset of the disability reduces the wage by 25 percent (Bound, 1989).¹⁶ Continuing DI eligibility and applicable benefit payments are then calculated each month using the rules outlined in Section 2. Each period, both wages and benefits are adjusted for nominal wage growth at an average annual rate of 5 percent. This is the intermediate assumption used for the projections of the Social Security Trust Fund (U.S. House of Representatives, 1994). Finally, we calculate the present discounted value of the income and earnings stream for each of the three benefit-wage scenarios for each of the labor supply choices using a discount rate of seven percent.^{17 18}

Appendix Tables A-1 and A-2 summarize our calculations, and Table 1 and Figure 3 show the main features. The Appendix tables show the actual discounted present values of earnings, benefits, and net income for the different types of workers under current law and under a strict SGA (that is, without the TWP and EPE) and these are graphically illustrated in Figure 3 for a medium-wage worker. Under current law, as hours of work for the medium wage worker increase from zero to 10 per week, the present discounted value (PDV) of net income increases because earnings stay below SGA (the PDV of benefits therefore remains unchanged); but income then drops drastically with further hours of work because the SGA is exceeded and hence benefits drop to zero at the point at which the individual passes from the TWP into the EPE. Additional increases in labor supply increase total income because earnings go up and the PDV of benefits--from the initial 12-month period and the 9-month TWP--are unchanged.

¹⁵These wage/benefit scenarios are used by Social Security Administration (SSA) to illustrate benefits for typical workers (see Social Security Administration 1995, Table 2.A26). The "average" worker is the average for the labor force covered by social security, which may be higher than average among DI recipients (Bound, 1989).

¹⁶The low (minimum wage) worker does not incur the 25 percent decrease in wages. The post-disability wage levels used are \$4.90 for low wage, \$8.34 for average wage, and \$12.51 for high wage workers. Benefits equal \$557, \$880, and \$1134.

¹⁷Since we assume nominal wage growth of five percent per year, this implies a real interest rate of approximately 2 percent.

¹⁸We do not include deductions for federal, state, or payroll taxes and hence net income includes earnings plus DI benefits. Including these taxes would lead to higher MTR but would not change the substantive points on the effects of DI on earnings possibilities.

Table 1 shows the marginal and average tax rates corresponding to the figure for all three types of workers. The MTR is zero for both the low-wage and medium wage workers up to 10 hours per week, but the SGA is hit between 10 and 20 and hence MTRs exceed 100 percent. The high-wage worker hits the SGA between 0 and 10 hours per week instead. Average tax rates, which are more relevant for the nonworking DI recipient who is considering making a discrete jump to either 10, 20, or 40 hours per week, are often lower because the notch has less of an effect (since a wider range of the budget constraint is considered).¹⁹

Under a strict SGA program, a comparison of the two panels in Figure 3 shows that income is lower than under current law for hours of work greater than 10 per week because the TWP allows nine months of benefits while working, which is not allowed under a strict SGA program. This has two implications. First, it means that a strict SGA program would have higher MTRs and ATRs than under current law, and this is illustrated in Table 1. The difference is often large--MTRs often exceed 200 percent--and it could be expected that some initially non-working recipients would increase their labor supply as a result of current law (compared to a strict SGA program). Second, however, the higher net income amounts at hours greater than 10 implies that the DI program is more attractive under current law than it would be under a strict SGA program, and this can be expected to increase entry and decrease exit, thereby increasing the caseload and reducing work effort among new entrants. As shown in Appendix Tables A-1 and A-2, the increase in the PDV of income is often on the order of 15-30%. To take one example, under current law a medium-wage worker who leaves a 20-hour-week job to go onto DI to work 15 hours per week during the TWP period and after would experience a 27 percent increase in net income, despite the lower work level; whereas under a strict SGA program he would experience a 6 percent loss in net income.²⁰ Obviously he would be less likely

¹⁹The low-wage worker experiences a non-zero MTR going from 20 to 40 hours per week because we assume nominal wage rates grow at five percent per year but the SGA stays fixed in nominal terms. At 20 hours per week, the individual hits the SGA partway through the EPE period; at 40 hours per week, he hits it at the beginning of the EPE period. We choose to conduct the simulation in this way because it reflects actual, current law--the SGA is not indexed and is typically held fixed for many years.

²⁰In Table A-1, $.27 = (\$39,688 - \$31,171) / \$31,171$ and in Table A-2, $.06 = (\$31,171 - \$29,447) / \$31,171$.

to go onto DI under a strict SGA. This necessarily implies as well that a DI recipient who has chosen to work 15 hours per week during the TWP and who locates a 20-hour-per-week job off DI would lose income under current law if he leaves the rolls to take that job but would gain income under the strict SGA program.

IV. Reforming Work Incentives in the DI Program

As we noted in the Introduction, methods for increasing work incentives in the DI program continue to be discussed. In this section we will consider several of the reforms that have been proposed, including a simple reduction in the MTR akin to a negative income tax. We will consider both the theoretically expected effects and then conduct numerical simulations for their effects on tax rates and income.

A. Alternative Work Incentive Provisions

To stick close to reforms actually being proposed, we examine five changes to the DI program:

- (1) index the SGA amount to keep pace with wage growth;
- (2) provide a partial offset (MTR) of 50 percent on earnings above the monthly SGA, to be imposed after the TWP;
- (3) provide a partial offset (MTR) of 50 percent on earnings above \$85 a month, to be imposed after the TWP;
- (4) extend the TWP by 12 months; and
- (5) provide an earnings subsidy for disabled individuals.

The first four proposals were proposed by a panel of experts (National Academy of Social Insurance, 1994) and the fifth was proposed by Burkhauser and Daly (1996). Some of these proposals have made their way into recent congressional bills. In particular, the Jeffords bill (*Work Incentive and Self Sufficiency Act* of 1996) proposes to turn DI program into a strict SGA program enhanced with a MTR of 50% over SGA. The *Transition to Work Act* of 1997 includes a refundable tax credit modeled after the EITC which is available to those who lose DI benefits because of increases in earnings. No further congressional action has been taken

on these proposals.

The first reform simply increases the SGA and hence has a clear work-incentive rationale. The second and third reforms lower the MTR, as in a negative income tax, below 100 percent, and therefore eliminate the notch in the budget constraint. In one case the lower tax rate begins only above SGA whereas in the other case it begins at \$85 per month, an estimate of average work expenses. Since the SGA is currently \$500 per month, this latter change would actually increase the MTR over some low ranges of hours worked. The fourth reform simply extends the TWP for twelve months on top of the current nine.

The fifth reform differs substantially from the first four in that it is a reform that, in general, operates outside the DI system. We assume that the earnings subsidy is made available to the same population of disabled individuals as is currently eligible for DI. In our simulations, we consider an earnings subsidy equal in magnitude to the 1995 Earned Income Tax Credit (EITC). The Earned Income Tax Credit (EITC) is an earnings subsidy in the form of a refundable tax credit and it typically only available to families with children.²¹ Our simulation therefore can be thought as extending the EITC to all disabled workers, regardless of whether they have a child.²² The amount of the EITC depends on whether earnings fall in the subsidy, flat, or phaseout range of the credit. The subsidy range covers earnings up to \$6,160, over which the subsidy equals 34 percent of earnings generating a maximum credit of \$2,094. In the flat range, covering earnings between \$6,160 and \$11,290, the worker receives the maximum credit. In the phaseout range, the subsidy is reduced by 15.98 cents for each additional dollar in earnings such that the credit is fully phased out at earnings of \$24,396.²³ Workers earning more than \$24,396 are not eligible.

²¹The credit was introduced in 1975 to offset the social security tax but has been expanded significantly since the mid 1980s. Starting in 1994, a small EITC was made available to childless workers with earnings up to \$9,000.

²²In particular, we provide the EITC which is extended to families with one child. Since 1991, a more generous EITC has been made available to families with two or more children.

²³We use the parameters of the current EITC program for convenience. In practice, an earnings subsidy for disabled workers could also take the form of subsidies to the employer. At the level of generality of our simulation program, these are equivalent.

B. Expected Effects of Changes to DI Work Incentives

An increase in the SGA increases the notch point in the budget constraint and hence leads to increases in work effort among current recipients. However, it increases the DI caseload by drawing some of the eligible population onto the rolls and hence has ambiguous impacts on average work effort among the disabled. These effects would manifest themselves in both the application phase and the EPE phase. In the application phase, the higher level of SGA would permit workers to work more while waiting for benefits to begin, but would for that same reason lower the costs (or raise the benefits) of going onto DI among disabled individuals who are working off DI. During the EPE, as illustrated in Figure 4, an increase in the notch point encourages additional work among those initially at the notch (arrow 1), but lowers labor supply among those above the initial level of SGA. Some of the latter individuals (arrow 2) are made eligible by the increase in SGA and some (arrow 3) are encouraged to reduce earnings to be at or below the new SGA, but in either case work effort falls and the caseload rises.

Similarly, adding a partial benefit or MTR on earnings during the EPE will tend to increase work levels among current DI recipients, but the impact on overall work effort among the disabled is indeterminate in direction. Figure 5 shows this change. The budget constraint under current law during the EPE is ABCDE. Adding a MTR of 50% above SGA gets rid of the notch and phases out benefits at a rate of 50 cents for each dollar earned over SGA, shown by the segment CE with a slope of one half the wage. This reform has some positive work incentives for those initially at the notch (arrow 1) but work disincentives for those who come onto the rolls (arrows 2 and 3). The caseload unambiguously rises. The potential increase in the caseload is quite large under this expansion: using the average benefit in 1993 of \$642, the break-even earnings level increases from \$500 per month (current SGA) to about \$1800 per month or \$22,000 per year.²⁴

²⁴The benefit formula becomes $DIBEN - 0.5*(EARNINGS - 500)$, which using a DIBEN of \$642 equals zero when earnings equal $2*642+500$ or \$1784.

Imposing a 50 percent MTR on earnings over an \$85 exclusion during the EPE differs from the other reforms because benefits would be lower than they are under current law for some ranges of earnings, for the \$85 exclusion is below the SGA level of \$500. By increasing the tax rate (from 0 to 50 percent) in ranges less than \$500, we may see a reduction in work effort for current recipients. However, by eliminating the notch (and its high MTR) and extending benefits past the SGA, we may see an increase in work levels among some recipients. For this program change, the caseload as well as the net work effects are ambiguous. The direction of the change in entry and exit rates is not determinant since for some hours ranges the program has been expanded while for others, the program is less generous.

Increasing the length of the TWP allows recipients to work for more months before being taxed (e.g. before entering the EPE); hence the effective MTR (in present value terms) decreases. This can be expected to increase work levels, and to increase the length of time spent on the program for current participants. However, it can also be expected to attract new participants and to reduce exit rates, both of which will reduce work effort levels and increase the size of the caseload.

The earnings subsidy differs from the other policy changes because it affects income off the DI program instead of on it. For this reason, we call it "non-DI" reform. Unlike the other policy simulations, the introduction of a pure earnings subsidy unambiguously increases labor supply and reduces the size of the DI caseload. Labor supply increases because the return to an hour of work increases at all levels of hours of work. Program participation decreases, at minimum, because increases in labor supply will often lead individuals off the DI rolls. For those who stay on the DI rolls, the effect of an earnings subsidy on labor supply depends on how the subsidy is treated by the program. If it is ignored by the program altogether, labor supply will increase while on DI; but if it is included as earnings for purpose of SGA calculation, it will imply that the SGA is hit at an earlier hours point and this will have separate effects. In our simulations below, we assume the latter treatment. However, the EITC, upon which we model our earnings subsidy, has a 'flat' and 'phaseout' range which are well-known to induce reductions in labor supply for those already

working (Eissa and Liebman 1996). Therefore, on net, the effect of this type of earnings subsidy on labor supply is ambiguous as well.²⁵

C. Income, Earnings, and Tax Rates Under Alternative Work Incentives

In this section we apply the same simulation model we used previously to simulate the effects of the five reforms under discussion. For the four DI reforms, Appendix Tables A-3 to A-6 present the PDVs of earnings, benefits, and net income at different hours of work for the three wage levels. The results are summarized in Table 2.

The first reform, indexing the SGA, pushes the SGA up to a higher hours level. This affects MTRs and ATRs at the hours points we show only for the low-wage worker, who now does not hit the notch until 40 hours per week. The medium-wage and high-wage workers hit the notch at the same discrete hours point as before. Therefore, at least for the low-wage recipient, there is reason to expect increased work incentives from this reform.

Reducing the MTR eliminates the notch entirely during the EPE and hence there are no more excessively high MTRs facing DI recipients (simulations 3 and 4). The MTRs fall from their current-law levels of as high as 174 percent, for the medium-wage worker, to 23 or 36 percent, for example. However, the magnitude of this decline is somewhat exaggerated because, while the high MTR at the notch point is eliminated, the MTR over hours of work beyond that is increased. Thus, for example, for both medium-wage and high-wage workers, the MTR above the (old) SGA level rises from 0 to 36 percent. This is a necessary consequence of having to phase out benefits, and illustrates the general principle that the elimination of a notch is akin to taking a very high MTR at one point and spreading it out over other points, raising the MTRs

²⁵Because the EITC is available to workers only, it unambiguously leads to higher rates of labor force participation. Empirical studies have shown that the added worker effect seems to dominate the potential reduction in labor supply among current workers to lead to a net increase in labor effort for single mothers (Eissa and Liebman 1996) but not necessarily among married couples who, typically, have larger initial labor force participation rates (Eissa and Hoynes 1997).

at many of those other points. This can also be seen in Table 2 inasmuch as the reduction in ATRs is considerably less than the reduction in MTRs (see also Figure 5). The labor supply effects of the change are therefore ambiguous.²⁶

Extending the TWP by twelve months generally lowers MTRs and ATRs because a larger fraction of the simulation period the individual faces a tax rate of zero. This has little effect on the high-wage worker but lowers tax rates for the low-wage worker by a considerable amount, suggesting that positive effects on labor supply could result.

Table 3 and Figure 6 illustrate the effects of an earnings subsidy on tax rates and income. The first earnings subsidy we illustrate assumes that the DI program ignores the subsidy amount entirely except when comparing earnings to SGA ("earnings subsidy for all disabled workers"). The second earnings subsidy we examine is one that does not allow the subsidy to be received by workers who are on the DI rolls. Much of the employment obtained by DI recipients come from sheltered work environments outside the regular labor market, and it is not clear that the earnings from those jobs would be treated as available for subsidy. Alternatively, the DI program could treat the earnings subsidy as a form of nonlabor income and subject it to 100-percent tax, which would also effectively make it unavailable to DI recipients. A earnings subsidy not available to DI recipients should give the individual a somewhat larger incentive to increase labor supply and to leave the DI rolls than the universal earnings subsidy available to both recipients and non-recipients.

Figure 6 shows that, under the earnings subsidy for all disabled workers, net income levels monotonically rise (except for the initial SGA point). This is reflected in Table 3, which shows the MTR to change from positive to negative for the low-wage worker at two of the hours points. The inclusion of the earnings subsidy in the SGA determination implies a higher MTR when going from 10 to 20 hours, but the more relevant ATRs show a reduction throughout the entire range from the reform. MTRs and ATRs generally fall at the 20 and 40 hours points for the medium-wage and high-wage workers, although little for

²⁶ The BRR reduction over \$85 also increases the MTR at very low-hours ranges, as noted previously in the text.

the latter, who receives only a small subsidy.

Under the earnings subsidy available only to non-DI recipients, Figure 6 shows that income amounts are the same as in Figure 1 except for the addition of the earnings subsidy at hours of work of 15 or more, when the individual is off DI. In Table 3 it can be seen that this earnings subsidy has a mixed set of effects on the MTRs and ATRs relative to the universal subsidy, sometimes increasing them and sometimes decreasing them depending on the hours point and the individual wage level.²⁷

The results presented thus far show, for the most part, the possible labor supply increases and caseload reductions from many of the reforms. They do not show, at least directly, the offsetting changes in incentives for entry and exit that would be associated with many of those reforms. Tables 4 and 5 illustrate those effects by showing the percent gains and losses in net income that would result from movements off, or onto, the rolls at different hours points under current law and under the reforms for a medium-wage individual. Thus, Table 4 shows exit-rate incentives by illustrating the changes in net income that would result from being initially on the rolls (when net income includes the PDV of benefits) but then moving off the rolls (when net income only includes the PDV of earnings) at the end of the TWP. Under current law and the strict SGA, for example, the medium wage worker is above SGA at 20 hours per week and at 40 hours per week; hence leaving the rolls and continuing to work at these hours would not affect net income. Column three shows that increasing hours of work from 0 to 20 when going off would result in net-income losses because earnings would not be enough to make up for the benefit loss (implying presumably that this action would never be taken) but increasing hours from 20 to 40 would result in earnings increases exceeding benefit losses and hence increases in net income (and therefore would be undertaken if the value of lost leisure were exceeded by the value of the additional income).

As for the reforms, an indexation of the SGA would have no effect on the monetary incentives or

²⁷Earnings subsidies are most effective for encouraging work among low wage workers. The subsidy could easily be expanded to provide greater incentives for higher wage workers.

disincentives to leave the rolls because it would not affect income at the particular hours points we have chosen. However, the other three DI reforms significantly reduce the financial incentive to leave the rolls. Reducing the MTR would imply net income losses of 7 to 33 percent among workers who did not increase their work effort when exiting. In addition, individuals who, in the absence of the MTR reduction would have experienced a 48 percent increase in net income by working 40 hours off the rolls instead of 20 while on, would experience either much smaller increases (9 percent) or actual reductions (-1 percent) in net income. It is in this range that the MTR reduction has the largest impact on increasing income while on the rolls and thus reduces the incentives to exit. Extending the TWP by 12 months also reduces incentives to leave, because benefits are higher while on the rolls, but not by as large an amount as the MTR reductions. The effects of the earnings subsidies on exit incentives are rather small because the largest effect of those subsidies are in hours-worked ranges where the individual is already effectively off DI and working above the SGA. However, while the earnings subsidies do not greatly increase the leaving incentives for medium wage workers, they at least do not reduce them significantly, unlike the DI reforms.

Tables 5 shows the percent change in income from moving from off the rolls (only earnings) to the rolls (earnings plus benefits), and by either working the same amount or reducing work effort in the process. Under current law, a medium wage recipient has large income gains of 52 or 26 percent, depending on whether he works part-time or full-time, if he goes onto DI (benefits are always received during the application period and the TWP). If the individual quits a part-time job to go onto the rolls and not work, income still increases by a large amount (39 percent) although not by as much as it would if he were to continue working while on the rolls; this would therefore seem to be a utility-maximizing move. However, going onto the rolls and reducing hours from 40 to 20 does not increase benefits by very much and therefore results in a net income loss (to be balanced against the increased value of leisure).

Except for the indexed SGA, which again has no effect, the DI reforms always increase the net income gain from going onto the rolls without changes in hours worked, often by large amounts (107 percent

and 128 percent, for example, in the part-time range where the MTR reduction has its biggest effect). More important, while the incentives for quitting work entirely are unaffected by the reforms, since none of them alter benefits at zero hours, the income losses attendant upon reducing from full-time to part-time work are either greatly attenuated (for the TWP extension) or reversed in sign (MTR reductions). In the latter case, therefore, net income can be increased by reducing hours and going onto the rolls, which again would appear to be a utility-maximizing choice.

The earnings subsidies have the opposite effects as the reforms if hours are unchanged, for they reduce the financial incentives to go onto the rolls, even though those net income gains are still positive (23 to 42 percent in the table). Net income gains from quitting work from a part-time job are also lower under the earnings subsidies, for those subsidies increase net income for workers off the rolls but not nonworkers. However, income losses from leaving a full-time job to work part-time on the rolls entail slightly smaller income penalties than under current law, but this is because net income losses and gains from changes in earnings in the phaseout range of an earnings subsidy are reduced even for those who are off the rolls. In the 20-to-40 hours range for medium-wage workers, earnings are above SGA regardless and hence there is no additional benefit gain from going onto the rolls.

V. Conclusions and Policy Implications

As the issue of increasing work incentives in the DI program becomes of greater policy interest, it is important to understand the implications of changing financial inducements through changes in benefit formulas. Our discussion of the expected effects of such changes suggest that they are not as likely to be as effective as they first appear. Lying behind this potential ineffectiveness are a set of possible explanations which involve new entry onto the programs as well as decreased exit. Changes in labor supply for these groups may offset the increase in labor supply among those that stay on the program. Unfortunately, the available empirical research on DI does not allow us to reach any conclusions on the magnitude of the

response. But the direction of the different types of responses that result from financial inducements, both the intended increases in work effort and the unintended reductions, should be present. This leads us to urge caution in using financial inducements as a means of work-incentive reform in DI without further, concrete evidence of their effectiveness.

As an alternative, increasing work effort among the disabled may be achieved by the use of work, employment and training programs and/or wage subsidies. Both of these policies have been advanced in recent years for the AFDC program, in part due to the perceived failure of within-program financial inducements. This shift also reflects a society-wide change in attitudes toward work among women with children, as it becomes increasingly the norm for such women to work rather than stay at home. A similar change in attitudes toward the disabled appears to have occurred, with many arguing that all recipients should work to the degree they can. However, the use of program based financial inducements is still more favorably viewed in policy discussions of DI (and SSI) than in the AFDC and other welfare programs, which is not necessarily justified by the evidence.

The attractiveness of an earnings subsidy such as the EITC is that it has the potential to increase work and earnings and to reduce the DI caseload at the same time. The philosophy behind the EITC and similar private-sector earnings subsidy programs is diametrically opposite to that lying behind the use of within-program financial inducements to work more while on DI, for the latter has the potentially deleterious consequences of increasing the caseload and possibly reducing work effort which we have discussed at length in our paper. These deleterious effects would not be present if financial inducements were offered only for off-DI (or both on- and off-DI) work. Policy discussions of disability programs might fruitfully turn to such programs, perhaps by investigating special private-sector earnings subsidy programs for the disabled or modifications in the EITC to make more disabled individuals eligible for its benefits.

To determine the effectiveness of any of these policies in increasing work effort and reducing caseloads in the DI program, major research gaps need to be filled. Secondary analysis of existing data sets

using econometric techniques must be pursued with more of an eye toward estimating wage and substitution elasticities, for example, although we recognize the difficulties in doing so. Alternatively, microsimulation models either large-scale or small-scale could be constructed and the effects of different work-incentive provisions could be predicted based upon a range of assumed responsiveness levels and elasticities; this would provide at least some indication of how large or small responsiveness needs to be for work-incentive provisions to have a genuine positive effect. Finally, direct experiments or demonstrations on the caseload would be helpful in obtaining estimates of the response to specific program initiatives, although it needs to be emphasized that program evaluations need to be designed to capture both the exit and entry effects of financial inducements as well.

VI. References

Bound, John. "The Health and Earnings of Rejected Disability Insurance Applicants." American Economic Review 79(3) (June 1989): 482-503.

_____. "The Health and Earnings of Rejected Disability Insurance Applicants: Reply," American Economic Review (December 1991): 1427-34.

Burkhauser, R. and M. Daly. "Employment and Economic Well-Being Following the Onset of a Disability: The Role for Public Policy." In Disability, Work and Cash Benefits, eds. J.Mashaw, V.Reno, R.Burkhauser, and M.Berkowitz. Kalamazoo: Upjohn, 1996.

Eissa Nada and Jeffrey Liebman. "Labor Supply Response to the Earned Income Tax Credit." Quarterly Journal of Economics 111 (May 1996): 605-637.

Eissa, Nada and Hilary Hoynes. "The Earned Income Tax Credit and Labor Supply: Married Couples", mimeo, University of California (1997).

Halpern, J. and J. Hausman. "Choice Under Uncertainty: A Model of Applications for the SSDI Program." Journal of Public Economics 31 (1986): 131-61.

Haveman, Robert and Barbara Wolfe. "The Decline in Male Labor Force Participation: Comment," Journal of Political Economy 92(3) (1984): 532-41.

Hoynes, Hilary and Robert Moffitt. "The Effectiveness of Financial Work Incentives in SSDI and SSI: Lessons from Other Transfer Programs," in J. Mashaw et al. (eds.), Disability, Work and Cash Benefits. Kalamazoo: Upjohn, 1996.

Leonard, Jonathan. "The Social Security Disability Program and Labor Force Participation." NBER Working Paper #392, (August 1979).

Levy, Frank. "The Labor Supply of Female Heads, or AFDC Work Incentives Don't Work Too Well." Journal of Human Resources 14 (Winter 1979): 76-97.

Moffitt, Robert. "Incentive Effects of the U.S. Welfare System: A Review." Journal of Economic Literature 30 (March 1992): 1-61.

National Academy of Social Insurance. Preliminary Status Report of the Disability Policy Panel, March 1994.

Parsons, Donald. "The Decline in Male Labor Force Participation." Journal of Political Economy 88(1) (1980a): 117-34.

_____. "Racial Trend in Male Labor Force Participation." American Economic Review 70 (1980b): 911-20.

_____. "Disability Insurance and Male Labor Force Participation: A Response to Haveman and Wolfe," Journal of Political Economy 92(3) (1984): 542-549.

_____. "The Health and Earnings of Rejected Disability Insurance Applicants: Comment," American Economic Review (December 1991): 1419-26.

Social Security Administration, U.S. Department of Health and Human Services. Annual Statistical Supplement to the Social Security Bulletin, Washington DC: Government Printing Office (1992).

Social Security Administration, U.S. Department of Health and Human Services. Annual Statistical Supplement to the Social Security Bulletin, Washington DC: Government Printing Office (1995).

U.S. House of Representatives, Committee on Ways and Means. Background Material and Data on Programs within the Jurisdiction of the Committee on Ways and Means. Washington: Government Printing Office (1994).

U.S. House of Representatives, Committee on Ways and Means. Background Material and Data on Programs within the Jurisdiction of the Committee on Ways and Means. Washington: Government Printing Office (1996).

Figure 1
DI Budget Constraint During EPE

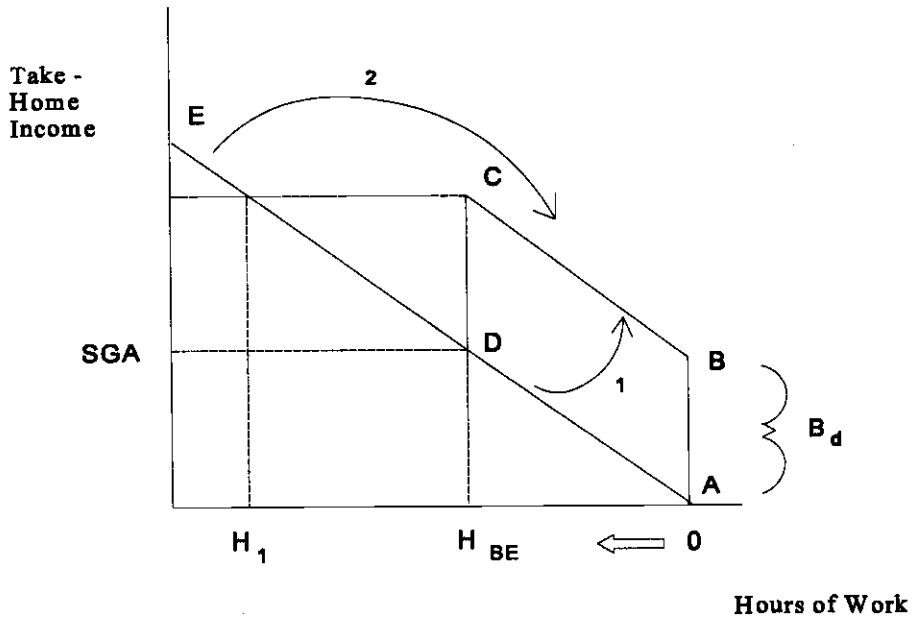

Figure 2
Effects of Adding TWP to Strict SGY Program

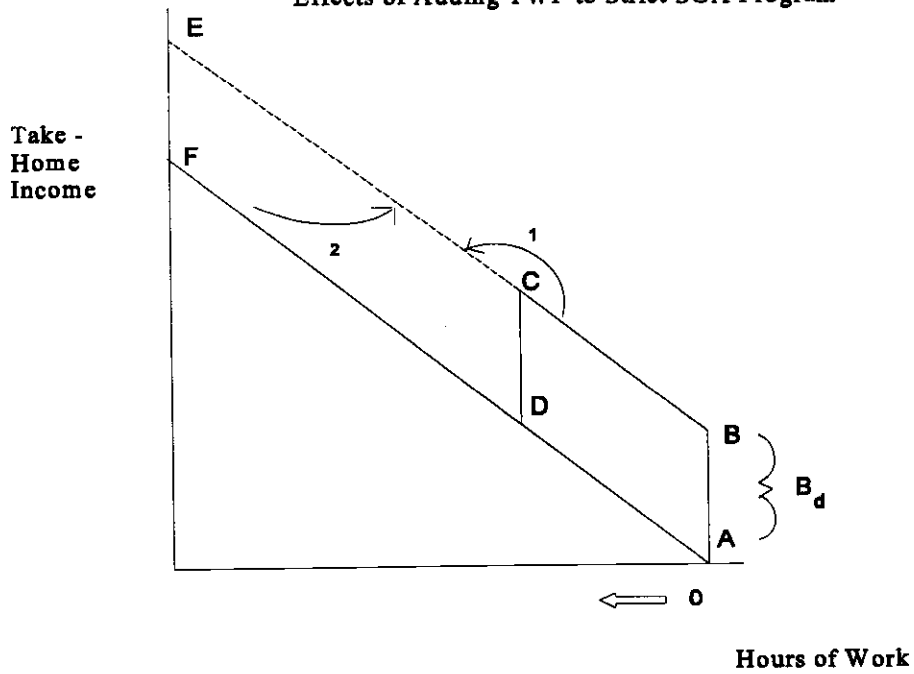

Figure 3
Income Opportunities for DI Participants, Medium Wage Worker

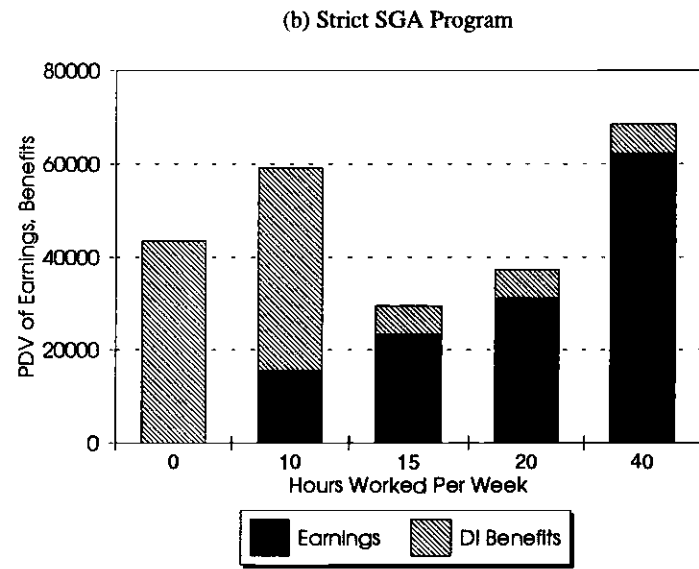
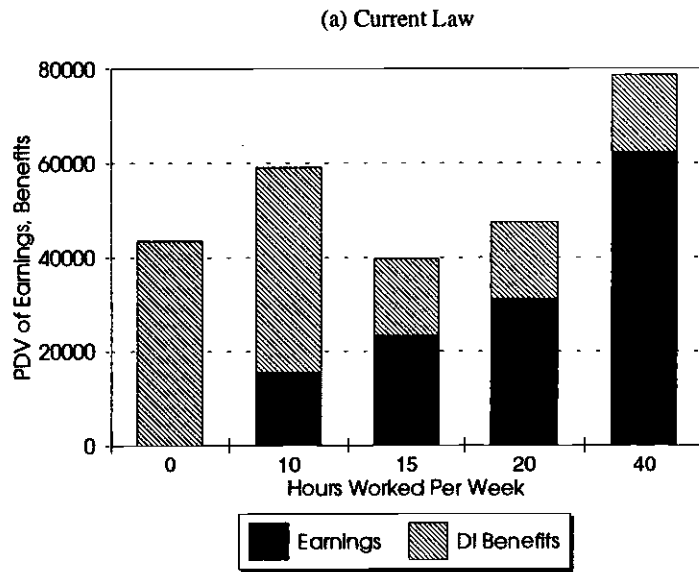

Figure 4
Effect of Increasing SGA on EPE Budget Constraint

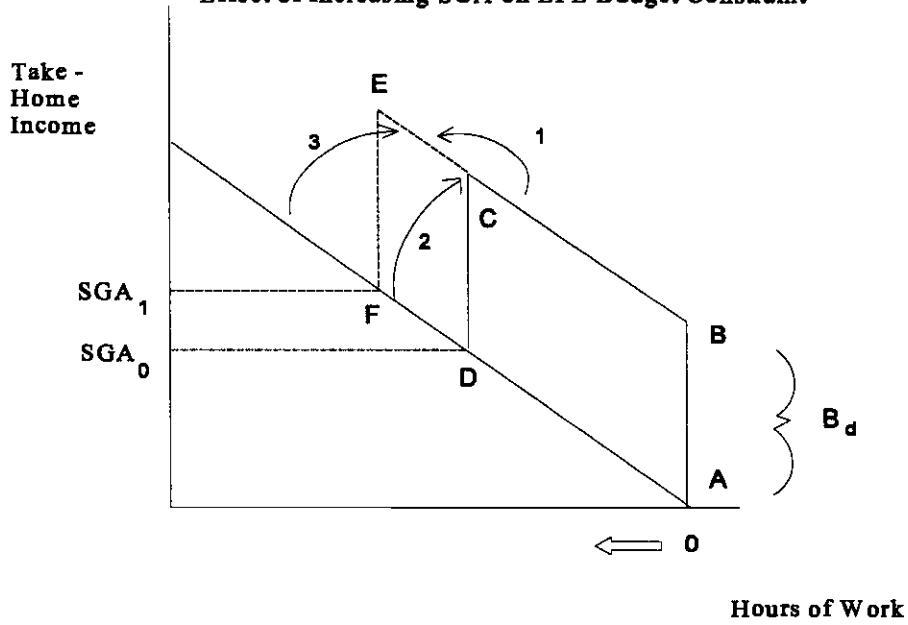

Figure 5
Effects of Adding 50% MTR over SGA

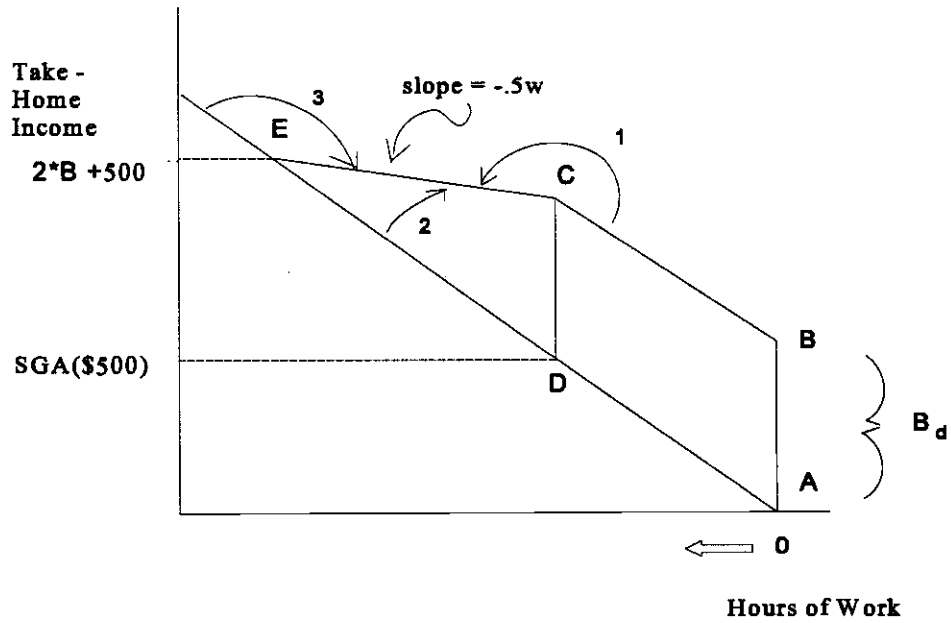

Figure 6
Income Opportunities for DI Participants, Medium Wage Worker

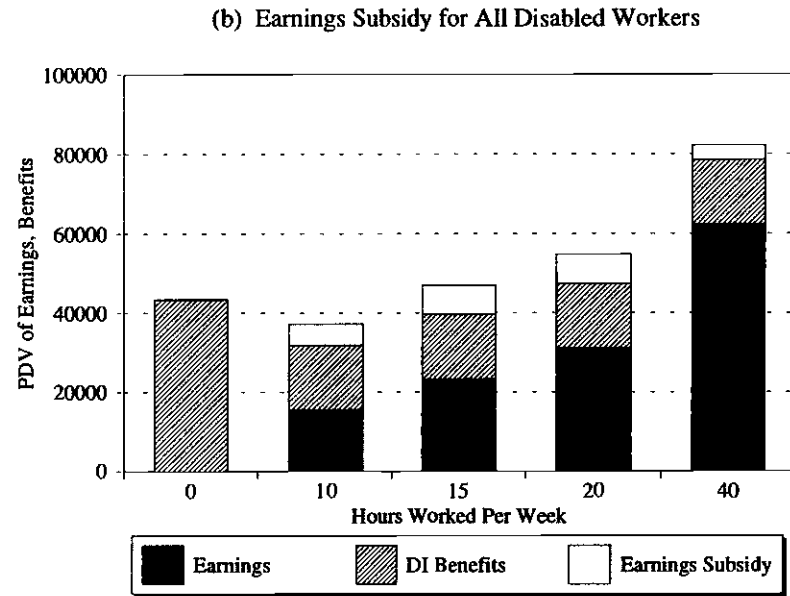
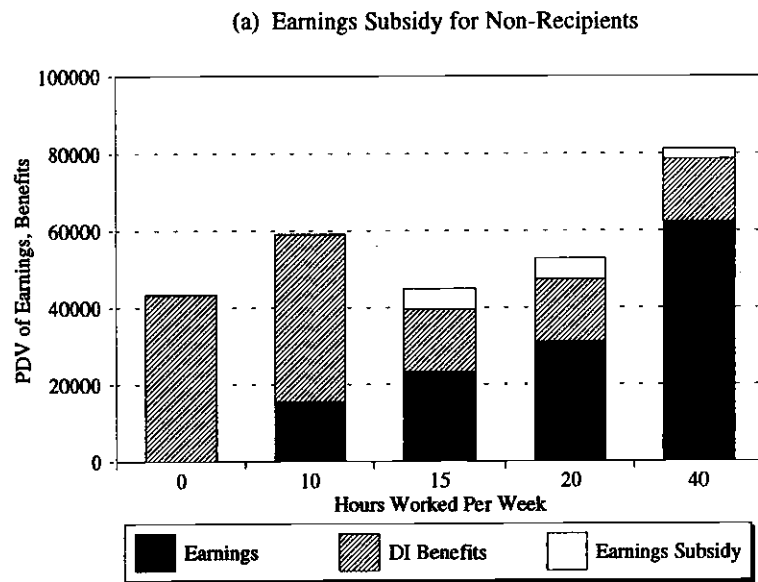

Table 1
Tax Rates in the DI Program Under Current Law and Strict SGA programs,
By Wage Level and Hours of Work ¹
(Percent)

	<i>Marginal Tax Rate (%)</i> ²			<i>Average Tax Rate (%)</i> ³		
	10 hrs	20 hrs	40 hrs	10 hrs	20 hrs	40 hrs
<u>Low Wage Worker</u>						
Current Law	0	124	32	0	62	47
Strict SGA	0	124	67	0	62	65
<u>Medium Wage Worker</u>						
Current Law	0	174	0	0	87	44
Strict SGA	0	240	0	0	120	60
<u>High Wage Worker</u>						
Current Law	150	0	0	150	75	37
Strict SGA	206	0	0	206	103	52

Notes:

1. Results of simulation over 57 month period. See text for details.
2. Marginal tax rates are calculated as one minus the change in income over the change in earnings resulting from increasing hours of work from the prior level.
3. Average tax rates are calculated as one minus the change in income over the change in earnings resulting from increasing hours of work from the no work choice.

Table 2
Tax Rates in the DI Program Under Current Law and Proposed DI Reforms,
*By Wage Level and Hours of Work*¹
(Percent)

	<i>Marginal Tax Rate (%)</i> ²			<i>Average Tax Rate (%)</i> ³		
	10 hrs	20 hrs	40 hrs	10 hrs	20 hrs	40 hrs
<u>Low Wage Worker</u>						
1. Current Law	0	124	32	0	62	47
2. Index SGA	0	0	94	0	0	47
3. 50% MTR over SGA	0	0	31	0	0	15
4. 50% MTR over \$85	24	36	36	24	30	33
5. Extend TWP 12 months	0	118	0	0	59	30
<u>Medium Wage Worker</u>						
1. Current Law	0	174	0	0	87	44
2. Index SGA	0	174	0	0	87	44
3. 50% MTR over SGA	0	23	36	0	12	24
4. 50% MTR over \$85	29	36	36	29	33	35
5. Extend TWP 12 months	0	110	0	0	55	27
<u>High Wage Worker</u>						
1. Current Law	150	0	0	150	75	37
2. Index SGA	150	0	0	150	75	37
3. 50% MTR over SGA	3	36	36	3	20	28
4. 50% MTR over \$85	32	36	36	32	34	35
5. Extend TWP 12 months	94	0	0	94	47	24

Notes:

1. Results of simulation over 57 month period. See text for details.
2. Marginal tax rates are calculated as one minus the change in income over the change in earnings resulting from increasing hours of work from the prior level.
3. Average tax rates are calculated as one minus the change in income over the change in earnings resulting from increasing hours of work from the no work choice.

Table 3
Tax Rates in the DI Program Under Current Law and Non-DI Reforms,
By Wage Level and Hours of Work ¹
(Percent)

	<i>Marginal Tax Rate (%)</i> ²			<i>Average Tax Rate (%)</i> ³		
	10 hrs	20 hrs	40 hrs	10 hrs	20 hrs	40 hrs
<u>Low Wage Worker</u>						
1. Current Law	0	124	32	0	62	47
2. Earnings Subsidy for All	-34	154	-5	-34	60	27
3. Earnings Subsidy for Non-DI Recipients Only	0	91	20	0	46	33
<u>Medium Wage Worker</u>						
1. Current Law	0	174	0	0	87	44
2. Earnings Subsidy for All	140	-12	12	140	64	38
3. Earnings Subsidy for Non-DI Recipients Only	0	140	9	0	70	39
<u>High Wage Worker</u>						
1. Current Law	150	0	0	150	75	37
2. Earnings Subsidy for All	120	5	13	120	62	37
3. Earnings Subsidy for Non-DI Recipients Only	127	4	9	127	66	37

Notes:

1. Results of simulation over 57 month period. See text for details.
2. Marginal tax rates are calculated as one minus the change in income over the change in earnings resulting from increasing hours of work from the prior level.
3. Average tax rates are calculated as one minus the change in income over the change in earnings resulting from increasing hours of work from the no work choice.

Table 4
Percent Change in Income from Leaving DI under Current Law and Alternative Policies
Medium Wage Recipient ¹

	<i>Percent Change in Income by hours worked: ²</i>			
	20 hrs.	40 hrs.	0-20 hrs.	20-40 hrs.
Current Law	0	0	-10	48
Strict SGA	0	0	-10	61
<u>DI Reforms:</u>				
Index SGA	0	0	-10	48
50% MTR over SGA	-33	-13	-10	-1
50% MTR over \$85	-26	-7	-10	9
Extend TWP by 12 months	-17	-11	-10	22
<u>Reforms outside DI:</u>				
Earnings Subsidy	0	0	2	36
Earnings Subsidy, non-DI Recipients Only	0	0	2	38

Notes:

1. The recipient is assumed to leave DI after two years on the program. Under current law (and given our one year recuperation period) this occurs at the end of the trial work period (TWP). For comparability, when we simulated extending the TWP we still consider an exit from the program after two years. All simulations cover a 57 month period.

2. The scenarios in the first two columns assume that the worker does not change their hours of work when they leave DI. In the last two columns, the worker is assumed to increase hours worked when they leave the program, to the levels given.

Table 5
Percent Change in Income from Entering DI under Current Law and Alternative Policies
Medium Wage Recipient ¹

	<i>Percent Change in Income by hours worked: ²</i>			
	20 hrs.	40 hrs.	20-0 hrs.	40-20 hrs.
Current Law	52	26	39	-24
Strict SGA	19	10	39	-40
<u>DI Reforms:</u>				
Index SGA	52	26	39	-24
50% MTR over SGA	128	46	39	14
50% MTR over \$85	107	35	39	3
Extend TWP by 12 months	85	42	39	-8
<u>Reforms outside DI:</u>				
Earnings Subsidy	42	25	13	-17
Earnings Subsidy, non-DI Recipients Only	37	23	13	-20

Notes:

1. These calculations compare total income over the five year simulation period with and without DI benefits. The DI reforms only affect income opportunities on DI, but the non-DI reforms may affect both income on and off DI.
2. The scenarios in the first two columns assume that the worker does not change their hours of work when they enter DI. In the last two columns, the worker is assumed to decrease hours worked when they enter the program, to the levels given.

Table A-1
Earnings, Income and Tax Rates in the DI Program ¹
Current Law

	Earnings	Benefits	Net Income	Marginal Tax Rate (%)	Average Tax rate (%)
<i>Low Wage Worker</i>					
0 hours	\$0	\$27,498	\$27,498		
10 hours	\$9,157	\$27,498	\$36,655	0%	0%
15 hours	\$13,736	\$27,498	\$41,234	0%	0%
20 hours	\$18,314	\$16,153	\$34,467	248%	62%
40 hours	\$36,628	\$10,323	\$46,951	32%	47%
<i>Medium Wage Worker</i>					
0 hours	\$0	\$43,444	\$43,444		
10 hours	\$15,586	\$43,444	\$59,030	0%	0%
15 hours	\$23,378	\$16,310	\$39,688	348%	116%
20 hours	\$31,171	\$16,310	\$47,481	0%	87%
40 hours	\$62,342	\$16,310	\$78,652	0%	44%
<i>High Wage Worker</i>					
0 hours	\$0	\$55,984	\$55,984		
10 hours	\$23,378	\$21,018	\$44,396	150%	150%
15 hours	\$35,068	\$21,018	\$56,085	0%	100%
20 hours	\$46,757	\$21,018	\$67,774	0%	75%
40 hours	\$93,514	\$21,018	\$114,531	0%	37%

Notes:

1. Results of simulation over 57 month period starting in 1994. Earnings, income and benefits are the present discounted value of the stream over the simulation period. See text for details.

Table A-2
Earnings, Income and Tax Rates in the DI Program ¹
Strict SGA Program

	Earnings	Benefits	Net Income	Marginal Tax Rate (%)	Average Tax rate (%)
<i>Low Wage Worker</i>					
0 hours	\$0	\$27,498	\$27,498		
10 hours	\$9,157	\$27,498	\$36,655	0%	0%
15 hours	\$13,736	\$27,498	\$41,234	0%	0%
20 hours	\$18,314	\$16,153	\$34,467	248%	62%
40 hours	\$36,628	\$3,841	\$40,469	67%	65%
<i>Medium Wage Worker</i>					
0 hours	\$0	\$43,444	\$43,444		
10 hours	\$15,586	\$43,444	\$59,030	0%	0%
15 hours	\$23,378	\$6,069	\$29,447	480%	160%
20 hours	\$31,171	\$6,069	\$37,240	0%	120%
40 hours	\$62,342	\$6,069	\$68,411	0%	60%
<i>High Wage Worker</i>					
0 hours	\$0	\$55,984	\$55,984		
10 hours	\$23,378	\$7,820	\$31,199	206%	206%
15 hours	\$35,068	\$7,820	\$42,888	0%	137%
20 hours	\$46,757	\$7,820	\$54,577	0%	103%
40 hours	\$93,514	\$7,820	\$101,334	0%	52%

Notes:

1. Results of simulation over 57 month period starting in 1994. Earnings, income and benefits are the present discounted value of the stream over the simulation period. See text for details.

Table A-3
Earnings, Income and Tax Rates in the DI Program ¹
DI Reform: Index SGA

	Earnings	Benefits	Net Income	Marginal Tax Rate (%)	Average Tax rate (%)
<i>Low Wage Worker</i>					
0 hours	\$0	\$27,498	\$27,498		
10 hours	\$9,157	\$27,498	\$36,655	0%	0%
15 hours	\$13,736	\$27,498	\$41,234	0%	0%
20 hours	\$18,314	\$27,498	\$45,812	0%	0%
40 hours	\$36,628	\$10,323	\$46,951	94%	47%
<i>Medium Wage Worker</i>					
0 hours	\$0	\$43,444	\$43,444		
10 hours	\$15,586	\$43,444	\$59,030	0%	0%
15 hours	\$23,378	\$16,310	\$39,688	348%	116%
20 hours	\$31,171	\$16,310	\$47,481	0%	87%
40 hours	\$62,342	\$16,310	\$78,652	0%	44%
<i>High Wage Worker</i>					
0 hours	\$0	\$55,984	\$55,984		
10 hours	\$23,378	\$21,018	\$44,396	150%	150%
15 hours	\$35,068	\$21,018	\$56,085	0%	100%
20 hours	\$46,757	\$21,018	\$67,774	0%	75%
40 hours	\$93,514	\$21,018	\$114,531	0%	37%

Notes:

1. Results of simulation over 57 month period starting in 1994. Earnings, income and benefits are the present discounted value of the stream over the simulation period. See text for details.

Table A-4
Earnings, Income and Tax Rates in the DI Program ¹
DI Reform: 50% MTR over SGA

	Earnings	Benefits	Net Income	Marginal Tax Rate (%)	Average Tax rate (%)
<i>Low Wage Worker</i>					
0 hours	\$0	\$27,498	\$27,498		
10 hours	\$9,157	\$27,498	\$36,655	0%	0%
15 hours	\$13,736	\$27,498	\$41,234	0%	0%
20 hours	\$18,314	\$27,498	\$45,812	0%	0%
40 hours	\$36,628	\$21,911	\$58,539	31%	15%
<i>Medium Wage Worker</i>					
0 hours	\$0	\$43,444	\$43,444		
10 hours	\$15,586	\$43,444	\$59,030	0%	0%
15 hours	\$23,378	\$42,667	\$66,045	10%	3%
20 hours	\$31,171	\$39,838	\$71,009	36%	12%
40 hours	\$62,342	\$28,523	\$90,865	36%	24%
<i>High Wage Worker</i>					
0 hours	\$0	\$55,984	\$55,984		
10 hours	\$23,378	\$55,206	\$78,585	3%	3%
15 hours	\$35,068	\$50,963	\$86,031	36%	14%
20 hours	\$46,757	\$46,720	\$93,477	36%	20%
40 hours	\$93,514	\$29,747	\$123,261	36%	28%

Notes:

1. Results of simulation over 57 month period starting in 1994. Earnings, income and benefits are the present discounted value of the stream over the simulation period. See text for details.

Table A-5
Earnings, Income and Tax Rates in the DI Program ¹
DI Reform: 50% MTR over \$85

	Earnings	Benefits	Net Income	Marginal Tax Rate (%)	Average Tax rate (%)
<i>Low Wage Worker</i>					
0 hours	\$0	\$27,498	\$27,498		
10 hours	\$9,157	\$25,281	\$34,438	24%	24%
15 hours	\$13,736	\$23,619	\$37,355	36%	28%
20 hours	\$18,314	\$21,957	\$40,271	36%	30%
40 hours	\$36,628	\$15,309	\$51,937	36%	33%
<i>Medium Wage Worker</i>					
0 hours	\$0	\$43,444	\$43,444		
10 hours	\$15,586	\$38,893	\$54,479	29%	29%
15 hours	\$23,378	\$36,065	\$59,443	36%	32%
20 hours	\$31,171	\$33,236	\$64,407	36%	33%
40 hours	\$62,342	\$21,921	\$84,263	36%	35%
<i>High Wage Worker</i>					
0 hours	\$0	\$55,984	\$55,984		
10 hours	\$23,378	\$48,604	\$71,983	32%	32%
15 hours	\$35,068	\$44,361	\$79,429	36%	33%
20 hours	\$46,757	\$40,118	\$86,875	36%	34%
40 hours	\$93,514	\$23,145	\$116,659	36%	35%

Notes:

1. Results of simulation over 57 month period starting in 1994. Earnings, income and benefits are the present discounted value of the stream over the simulation period. See text for details.

Table A-6
Earnings, Income and Tax Rates in the DI Program ¹
DI Reform: Extend TWP

	Earnings	Benefits	Net Income	Marginal Tax Rate (%)	Average Tax rate (%)
<i>Low Wage Worker</i>					
0 hours	\$0	\$27,498	\$27,498		
10 hours	\$9,157	\$27,498	\$36,655	0%	0%
15 hours	\$13,736	\$27,498	\$41,234	0%	0%
20 hours	\$18,314	\$16,678	\$34,992	236%	59%
40 hours	\$36,628	\$16,678	\$53,306	0%	30%
<i>Medium Wage Worker</i>					
0 hours	\$0	\$43,444	\$43,444		
10 hours	\$15,586	\$43,444	\$59,030	0%	0%
15 hours	\$23,378	\$26,349	\$49,728	219%	73%
20 hours	\$31,171	\$26,349	\$57,520	0%	55%
40 hours	\$62,342	\$26,349	\$88,692	0%	27%
<i>High Wage Worker</i>					
0 hours	\$0	\$55,984	\$55,984		
10 hours	\$23,378	\$33,955	\$57,333	94%	94%
15 hours	\$35,068	\$33,955	\$69,022	0%	63%
20 hours	\$46,757	\$33,955	\$80,711	0%	47%
40 hours	\$93,514	\$33,955	\$127,468	0%	24%

Notes:

1. Results of simulation over 57 month period starting in 1994. Earnings, income and benefits are the present discounted value of the stream over the simulation period. See text for details.

Table A-7
Earnings, Income and Tax Rates in the DI Program ¹
Non-DI Reform: Earnings Subsidy for All Disabled Workers

	Earnings	Benefits	Earnings Subsidy	Net Income	Marginal Tax Rate (%)	Average Tax rate (%)
<i>Low Wage Worker</i>						
0 hours	\$0	\$27,498	\$0	\$27,498		
10 hours	\$9,157	\$27,498	\$3,113	\$39,769	-34%	-34%
15 hours	\$13,736	\$15,628	\$4,670	\$34,033	225%	52%
20 hours	\$18,314	\$10,323	\$6,227	\$34,864	82%	60%
40 hours	\$36,628	\$10,323	\$7,220	\$54,172	-5%	27%
<i>Medium Wage Worker</i>						
0 hours	\$0	\$43,444	\$0	\$43,444		
10 hours	\$15,586	\$16,310	\$5,299	\$37,195	140%	140%
15 hours	\$23,378	\$16,310	\$7,220	\$46,909	-25%	85%
20 hours	\$31,171	\$16,310	\$7,220	\$54,701	0%	64%
40 hours	\$62,342	\$16,310	\$3,479	\$82,132	12%	38%
<i>High Wage Worker</i>						
0 hours	\$0	\$55,984	\$0	\$55,984		
10 hours	\$23,378	\$21,018	\$7,220	\$51,616	119%	119%
15 hours	\$35,068	\$21,018	\$7,220	\$63,305	0%	79%
20 hours	\$46,757	\$21,018	\$5,970	\$73,744	11%	62%
40 hours	\$93,514	\$21,018	\$0	\$114,531	13%	37%

Notes:

1. Results of simulation over 57 month period starting in 1994. Earnings, income and benefits are the present discounted value of the stream over the simulation period. See text for details.

Table A-8
Earnings, Income and Tax Rates in the DI Program ¹
Non-DI Reform: Earnings Subsidy for non-DI Recipients

	Earnings	Benefits	Earnings Subsidy	Net Income	Marginal Tax Rate (%)	Average Tax rate (%)
<i>Low Wage Worker</i>						
0 hours	\$0	\$27,498	\$0	\$27,498		
10 hours	\$9,157	\$27,498	\$0	\$36,655	0%	0%
15 hours	\$13,736	\$27,498	\$0	\$41,234	0%	0%
20 hours	\$18,314	\$16,153	\$2,986	\$37,453	183%	46%
40 hours	\$36,628	\$10,323	\$5,242	\$52,193	20%	33%
<i>Medium Wage Worker</i>						
0 hours	\$0	\$43,444	\$0	\$43,444		
10 hours	\$15,586	\$43,444	\$0	\$59,030	0%	0%
15 hours	\$23,378	\$16,310	\$5,242	\$44,930	281%	94%
20 hours	\$31,171	\$16,310	\$5,242	\$52,723	0%	70%
40 hours	\$62,342	\$16,310	\$2,526	\$81,178	9%	39%
<i>High Wage Worker</i>						
0 hours	\$0	\$55,984	\$0	\$55,984		
10 hours	\$23,378	\$21,018	\$5,242	\$49,638	127%	127%
15 hours	\$35,068	\$21,018	\$5,242	\$61,327	0%	85%
20 hours	\$46,757	\$21,018	\$4,334	\$72,109	8%	66%
40 hours	\$93,514	\$21,018	\$0	\$114,531	9%	37%

Notes:

1. Results of simulation over 57 month period starting in 1994. Earnings, income and benefits are the present discounted value of the stream over the simulation period. See text for details.