

NBER WORKING PAPER SERIES

A MULTI-RISK SIR MODEL WITH OPTIMALLY TARGETED LOCKDOWN

Daron Acemoglu
Victor Chernozhukov
Iván Werning
Michael D. Whinston

Working Paper 27102
<http://www.nber.org/papers/w27102>

NATIONAL BUREAU OF ECONOMIC RESEARCH
1050 Massachusetts Avenue
Cambridge, MA 02138
May 2020

Rebekah Anne Dix and Tishara Garg provided excellent research assistance. For comments and suggestions we thank Joe Doyle, Glenn Ellison, Eli Fenichel, Simon Johnson, Simon Mongey, Robert Shimer, and Alex Wolitzky. We thank Sang Seung Yi for providing us with the Korean case and mortality data. All remaining errors are our own. The views expressed herein are those of the authors and do not necessarily reflect the views of the National Bureau of Economic Research.

NBER working papers are circulated for discussion and comment purposes. They have not been peer-reviewed or been subject to the review by the NBER Board of Directors that accompanies official NBER publications.

© 2020 by Daron Acemoglu, Victor Chernozhukov, Iván Werning, and Michael D. Whinston. All rights reserved. Short sections of text, not to exceed two paragraphs, may be quoted without explicit permission provided that full credit, including © notice, is given to the source.

A Multi-Risk SIR Model with Optimally Targeted Lockdown
Daron Acemoglu, Victor Chernozhukov, Iván Werning, and Michael D. Whinston
NBER Working Paper No. 27102
May 2020
JEL No. I18

ABSTRACT

We develop a multi-risk SIR model (MR-SIR) where infection, hospitalization and fatality rates vary between groups—in particular between the “young”, “the middle-aged” and the “old”. Our MR-SIR model enables a tractable quantitative analysis of optimal policy similar to those already developed in the context of the homogeneous-agent SIR models. For baseline parameter values for the COVID-19 pandemic applied to the US, we find that optimal policies differentially targeting risk/age groups significantly outperform optimal uniform policies and most of the gains can be realized by having stricter lockdown policies on the oldest group. For example, for the same economic cost (24.3% decline in GDP), optimal semi-targeted or fully-targeted policies reduce mortality from 1.83% to 0.71% (thus, saving 2.7 million lives) relative to optimal uniform policies. Intuitively, a strict and long lockdown for the most vulnerable group both reduces infections and enables less strict lockdowns for the lower-risk groups. We also study the impacts of social distancing, the matching technology, the expected arrival time of a vaccine, and testing with or without tracing on optimal policies. Overall, targeted policies that are combined with measures that reduce interactions between groups and increase testing and isolation of the infected can minimize both economic losses and deaths in our model.

Daron Acemoglu
Department of Economics
MIT
50 Memorial Drive
Cambridge, MA 02142-1347
and NBER
daron@mit.edu

Iván Werning
Department of Economics, E52-536
MIT
50 Memorial Drive
Cambridge, MA 02142
and NBER
iwerning@mit.edu

Victor Chernozhukov
Department of Economics
Massachusetts Institute of Technology
77 Massachusetts Avenue
Cambridge, Mass. 02139
vchern@mit.edu

Michael D. Whinston
Sloan School of Management
and Department of Economics
Massachusetts Institute of Technology
100 Main St
Cambridge, MA 02142
and NBER
whinston@mit.edu

1 Introduction¹

The COVID-19 pandemic has already claimed the lives of more than 200,000 people (as of April 27, 2020), necessitated widespread lockdowns in much of the world, and caused the largest global recession of the last nine decades. A key tool for both researchers and policymakers to understand and control the pandemic is the classic SIR (Susceptible-Infectious-Recovered) model originally proposed by [Kermack, McKendrick and Walker \(1927\)](#). The SIR framework and its various extensions model the spread and ultimate containment of an infection in a setting where those who recover are immune to the disease and thus the susceptible population declines over time.² The simplest version of the model consists of three differential equations and provides a good first approximation to the dynamics of a range of infections.³ Several recent papers have started incorporating economic trade-offs and conducting optimal policy analysis within this framework (e.g. [Rowthorn and Toxvaerd, 2020](#), [Eichenbaum, Rebelo and Trabandt 2020a](#), [Alvarez, Argente and Lippi 2020](#), [Jones, Philippon and Venkateswaran, 2020](#), [Farboodi, Jarosch and Shimer, 2020](#) and [Garriga et al., 2020](#)).⁴

Three sets of assumptions in the baseline SIR model may need to be relaxed both for gaining a more holistic understanding of how an infection spreads and how it can be contained, and for better informing public policy. These are:

- I. Different subpopulations typically have different risks—different rates at which they become infected, need hospitalization or intensive care and may suffer fatalities. In addition, they may interact with other subpopulations at different rates, thus necessitating a “network version” of the basic SIR model (e.g., [Easley and Kleinberg, 2010](#)). Such network versions of the SIR model may behave very differently from a basic homogeneous-agent version of the framework. Even more

¹Visit our online MR-SIR simulator (GUI) to explore the model, the effect of simple policies and optimal polices, as one varies parameters: <https://mr-sir.herokuapp.com/>

²The most common epidemiological extensions of the basic model include either the “Exposed” who have not yet turned infectious (SEIR) or the “Asymptomatic” who may still infect others (SAIR) or both. See, for example, [Brauer, van den Driessche and Wu \(2008\)](#).

³See the references in [Lehman, Loberg and Clark \(2019\)](#) and a recent incisive review by [Avery, Bossert, Clark, Ellison and Ellison, 2020](#).

⁴See [Atkeson \(2020b\)](#) and [Stock \(2020\)](#) for an introduction into the SIR framework and its implications for COVID-19 in the US. [Berger et al. \(2020\)](#) study an SEIR model and examine simple policies with testing and conditional quarantine; see also ([Eichenbaum, Rebelo and Trabandt, 2020b](#)) for macroeconomic model with testing, showing the equilibrium response to simple policies. [Chari, Kirpalani and Phelan \(2020\)](#) consider a single group SIR model but where agents engage in different forms of interactions, e.g. some more contagious, and consider social distancing measures for each form of interaction. [Fernández-Villaverde and Jones \(2020\)](#) fit a standard SIR model to multiple regions (countries, states and cities) and uses the model to infer unobservables (such as number of recovered) and create forecasts.

importantly, they may call for “targeted” policies that treat groups differentially.⁵

- II. The “matching technology” in the basic SIR model is similar to the quadratic matching technology of the famous [Diamond \(1982\)](#) coconut model, where the number of matches between two groups (or within a group itself) is the product of the size of the two groups. Though this quadratic technology is a good approximation to matching in geographic contexts where contact is random, it is not necessarily so for other interactions (such as in workplaces, for matching between firms and workers, or in the context of certain types of leisure activities that take place in small groups). The form of the matching technology may have important implications.⁶
- III. The parameters of contact and infection are generally taken to be exogenously-given, but economic and social adjustments that individuals adopt by themselves and via changes in norms and policies of communities can significantly change these parameters.⁷

In this paper, which is part of a broader research agenda, we focus on (I) and (II) to develop a multi-risk version of the basic SIR model (which we refer to as the MR-SIR model). After describing the laws of motion of the susceptible, infectious and recovered populations by group, we turn to a quantitative analysis of optimal policy in this extended environment.

We focus on the special case of our model consisting of three groups—young (20-44), middle-aged (45-65) and old (65+) and where the only differences in interactions between the three groups come from differential lockdown policies. We base our parameter choices on other work on the COVID-19 pandemic and characterize different types of optimal policies. Consistent with other works in which the value of life is sufficiently high and the sizable fatality risk of the oldest group is taken into account, optimal uniform policies involve long lockdowns in order to keep the infection rate low. Despite these aggressive lockdowns, total fatalities reach 1.83% of the population,⁸ and economic

⁵Targeting could also be by area (both to contain the disease in a given locality and also because of differences in healthcare resources; e.g., [Friedman et al. 2020](#)) and by industry of employment (to protect the supply chain and give priority to essential industries).

⁶The same issues are discussed in the epidemiology literature, sometimes contrasting models with “mass action” (which correspond to quadratic matching) vs. “pseudo mass action” (which feature less increasing returns to scale and matching). See, for example, [McCallum et al. \(2001\)](#).

⁷[Eichenbaum, Rebelo and Trabandt \(2020a\)](#), [Jones, Philippon and Venkateswaran \(2020\)](#), [Farboodi, Jarosch and Shimer \(2020\)](#), [Kudlyak, Smith and Wilson \(2020\)](#) and [Garibaldi, Moen and Pissarides \(2020\)](#) are recent papers that take important steps in this direction. Early contributions include [Geoffard and Philipson \(1996\)](#) and [Fenichel \(2013\)](#).

⁸Throughout, by “population” we refer to the adult population (over 20 years old).

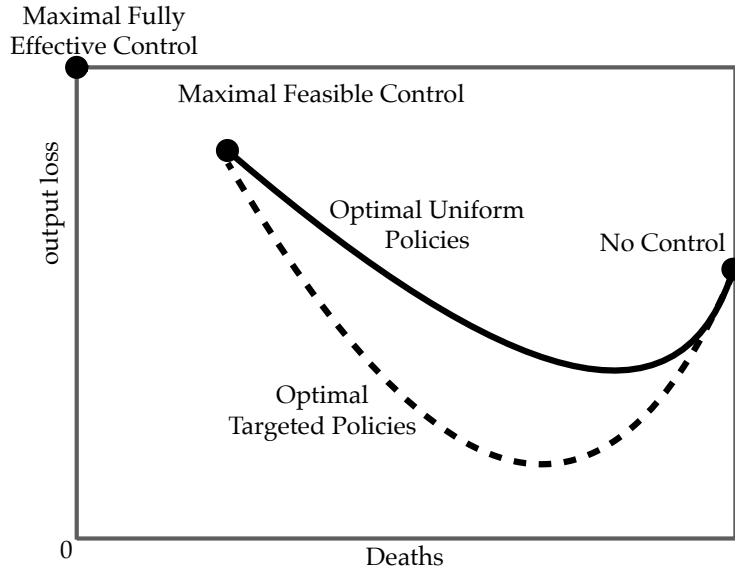

Figure 1: Frontier: economic vs. lives lost.

losses amount to 23.4% of one year’s GDP (these losses include the forgone productive contributions of those who die because of the pandemic). In contrast, targeted policies can significantly improve both on public health and economic outcomes. Interestingly, we find that semi-targeted policies that simply apply a strict lockdown on the oldest group can achieve the majority of the gains from fully-targeted policies. For example, a semi-targeted policy that involves the lockdown of those above 65 until a vaccine arrives can release the young and middle-aged groups back into the economy much more quickly, and still achieve a much lower fatality rate in the population (just above 1% of the population instead of 1.83% with the optimal uniform policy). This policy also reduces the economic damage from 24.3% to 12.8% of one year’s GDP. The reason is that, once the most vulnerable group is protected, the other groups can be reincorporated into the economy more quickly.⁹

We stress that there is much uncertainty about many of the key parameters for COVID-19 (Manski and Molinari, 2020) and any optimal policy, whether uniform or not, will be highly sensitive to these parameters (e.g., Atkeson, 2020a, Avery et al., 2020, Stock, 2020). So our quantitative results are mainly illustrative and should be interpreted with caution. Nevertheless, the qualitative finding that semi-targeted policies significantly outperform

⁹ Another interesting pattern is that optimal semi-targeted or fully-targeted policy waits for the vaccine for the oldest group, while controlling the rate of infection for the younger groups. The second part of this strategy has some similarity to the oft-discussed “herd immunity” property, which is defined as a situation in which the number or fraction of susceptible individuals is sufficiently low that the disease cannot propagate and infections decline. Herd immunity can be achieved by vaccination or by a sufficient proportion of the community becoming infected and then gaining immunity.

uniform policies is more general and is a consistent feature of all of our results.

The qualitative implications of our analysis can also be seen from the (“Pareto”) frontier between economic loss and loss of life, which represents the trade-off facing policymakers between output and lives lost and is illustrated in Figure 1. The frontier is upward sloping after a certain point, indicating that the absence of any mitigation policies will lead to both greater economic loss and more lives lost. Notably, the frontier for semi-targeted (or fully-targeted) policies is much closer to the “bliss point” represented by the origin than the frontier for uniform policies. This figure also helps us understand why targeted policies can save many lives—moving horizontally from the uniform policy frontier to the targeted policy frontier keeps the economic loss the same but substantially reduces fatalities.

We further show that when targeted policies are combined with measures to reduce interactions between groups, lives lost and economic damages can be substantially reduced. For example, if the frequency of interactions between the younger groups and the oldest group can be halved (for example, by changes in norms and laws segregating these groups), then in our baseline parameterization semi-targeted policies can reduce fatalities to 0.6% and the economic loss to less than 10%.

We also investigate the implications of the matching technology for the dynamics of the pandemic and optimal policy. To do this, we generalize the quadratic matching technology to allow for a flexible degree of “increasing returns to scale”.¹⁰ We find that “increasing returns to scale” in matching has important implications for optimal policy. With a constant returns to scale matching technology, the recovered offer greater protection to the susceptibles, while lockdowns are somewhat less effective (because the number of matches not decline as a quadratic). All the same, semi-targeted and fully-targeted policies continue to significantly outperform uniform policies.

We additionally investigate the implications of a faster discovery of a vaccine and more aggressive testing/tracing policies. These measures for containing and controlling the pandemic have obvious social benefits, but they do not obviate the advantage of targeted policies, which continue to significantly outperform uniform policies. The same conclusion applies when we consider a range of robustness checks on our parameters and other assumptions as well.

Overall, our results consistently highlight that targeted policies can improve both public health and economic outcomes. Moreover, as illustrated in Figure 2, when combined

¹⁰Specifically, we introduce a matching technology parameterized by $\alpha \in [1, 2]$, where $\alpha = 2$ corresponds to a quadratic matching technology, while $\alpha = 1$ is the constant returns to scale matching technology that is popular and empirically well grounded in the context of worker-firm search (e.g., [Pissarides, 1986](#), [Blanchard and Diamond, 1989](#)).

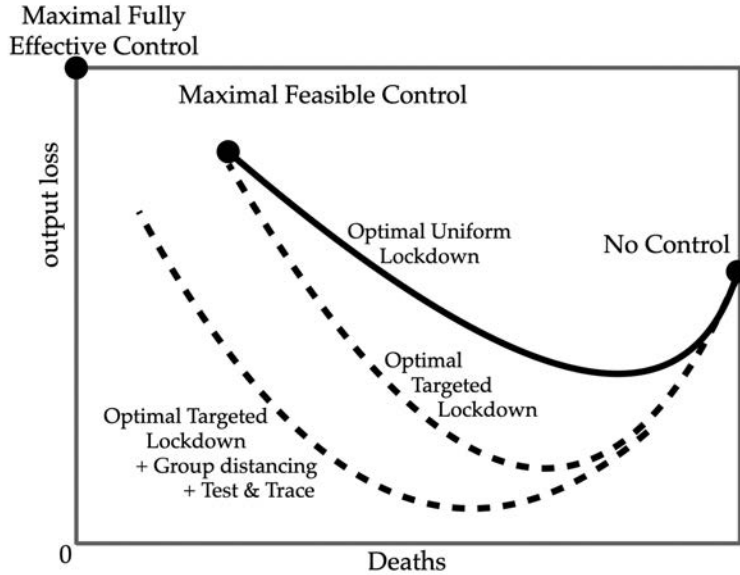

Figure 2: Frontier: economic vs. lives lost with additional policies.

with social distancing between groups and testing and isolation of the infected, targeted policies can significantly improve the trade-offs faced by policy-makers.

Several recent papers independently investigate the role of age-dependent hospitalization and fatality rates in SIR models (Gollier, 2020, Favero, Ichino and Rustichini, 2020, Rampini, 2020 and Bairoliya and İmrohoroğlu, 2020). The main differences between these papers and ours is: (1) our general treatment of dynamics of infection in an SIR model with multiple risk groups, different interaction structures and potentially imperfect testing and tracing, and (2) more importantly, our analysis of optimal policy. For example, our results showing that semi-targeted policies can significantly improve over optimal uniform policies and achieve the great majority of the gains of optimal fully-targeted policies have no counterparts in these papers. Glover et al. (2020) also study infection and economic dynamics in a model featuring heterogeneous risks. Their model incorporates sectoral differences (between an essential and a luxury industry) and redistribution between different groups as well. Glover et al. (2020)'s main emphasis is on the conflict between the young and the old about mitigation policies. Although they consider optimal policy, this policy is chosen from a parametric family and the main focus is on the contrast between this policy and those preferred by the young and the old.

The rest of the paper is organized as follows. The next section outlines the main elements of our Multi-Risk SIR model, presenting the continuous-time laws of motion for infectious, susceptible and recovered populations by group, as well as the objective function we employ in our optimal policy analysis. Section 3 describes our parameter choices

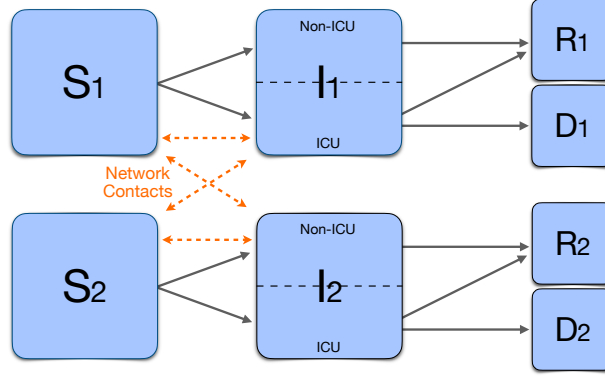

Figure 3: MR-SIR: Multiple-Risk Susceptible Infected Recovered Model. Solid lines show the flows from one state to another. Dashed lines emphasize interactions that take place across risk groups.

and numerical methods. Our main results are presented in Section 4, which also contains a number of robustness exercises. Section 5 contains our conclusions..

2 MR-SIR model

Our Multi-Risk SIR model is set in continuous time $t \in [0, \infty)$. Individuals are partitioned into risk groups $j = 1, \dots, J$ with N_j initial members.¹¹ The total population is normalized to unity so that $\sum_j N_j = 1$.

At any point in time t , individuals in group j are subdivided into those susceptible (S), those infected (I), those recovered (R) and those deceased (D),

$$S_j(t) + I_j(t) + R_j(t) + D_j(t) = N_j.$$

Agents move from susceptible to infected, then either recover or die.¹² We write $S(t) = \{S_j(t)\}_j$ and similarly for $I(t)$, $R(t)$ and $D(t)$. Groups interact with themselves as well as with each other, as described below.

Before describing the details, we anticipate one of our key equations. In the canonical

¹¹See Heesterbeek and Roberts (2007) and Bayham, Kuminoff, Gunn and Fenichel (2015) and the references therein for a discussion of age or stage structured compartmental epidemiological models.

¹²As is standard, we focus on the pandemic and abstract from other sources of deaths as well as new births

In addition, one could easily include an intermediate stage between S and I to capture exposed agents (E), leading to a standard SEIR model, instead of SIR. Adding this state is important for some diseases, when there is a significant lag between exposure and transmission. Arguably, this is not the case for COVID-19, as even asymptomatic individuals have been found to transmit the virus.

single group model, the key evolution equation is quadratic:

$$\text{new infections} = \beta SI.$$

In our model, absent lockdowns and isolations, we have

$$\text{new infections in group } j = S_j \frac{\sum_k \beta_{jk} I_k}{(\sum_k \beta_{jk} (S_k + I_k + R_k))^{2-\alpha}}$$

where $\{\beta_{jk}\}$ are parameters that control the contact rate between group j and k . Here $\alpha \in [1, 2]$ allows us to control the returns to scale in matching: when $\alpha = 1$ we have constant returns: infections double if S , I and R double; when $\alpha = 2$ we obtain the quadratic specification that, with a single group, boils down to the canonical SIR model. Below we develop the full model, complementing and extending this basic equation to include testing, isolation, lockdowns, hospital capacity, the arrival of a vaccine and other considerations etc.

2.1 Model Assumptions

Here we discuss the basic elements of our model and then turn to the dynamic equations describing the evolution of the state variables.

Infection, ICU, Fatality and Recovery. Susceptible individuals may become infected by coming into contact with infected individuals. Those infected may or may not require “ICU care”, a catch all label which we use to capture the need for ventilators and other specialized medical care. We suppose that the need for ICU is immediately realized upon infection. This saves us from having to carry around an additional state variable. Let l_j denote the constant fraction of infected people of type j needing ICU care. With Poisson arrival δ_j^i an ICU patient of type j recovers. Non-ICU patients do not die, and recover with Poisson arrival γ_j .

Only those needing ICU care may die. While in the ICU, patients die with Poisson arrival $\delta_j^d(t)$. We allow this death rate to be a function of total ICU needs relative to capacity, which may vary over time. We assume that

$$\gamma_j = \delta_j^d(t) + \delta_j^r(t)$$

,so that the proportions of ICU and non-ICU patients among the infected in group j do

not change over time.¹³

Let $H_j(t)$ denote the number of type j individuals needing ICU care at time t , so that $H_j(t) = \iota_j I_j(t)$. Total ICU needs are $H(t) = \sum_j H_j(t)$. We assume that the death probability conditional on ICU is a non-decreasing function of the number of patients

$$\delta_j^d(t) = \psi_j(H(t)),$$

for some given function ψ_j .¹⁴

Detection: Infection and Immunity. Detection of infected individuals as well as their isolation is assumed to be imperfect. To avoid additional state variables, for each infected individual it is determined immediately upon infection whether detection and isolation is possible. Let us denote by τ_j the constant probability that an infected individual of type j not needing ICU care is detected as infected and becomes isolated. Detection includes the presentation of symptoms as well as testing without symptoms. Similarly, we let ϕ_j denote the probability that an individual of type j needing ICU care is detected and isolated. While it may be reasonable to set $\phi_j = 1$, we allow $\phi_j < 1$ to nest earlier work, such as [Alvarez et al. \(2020\)](#), that did not model ICU needs explicitly (by setting $\tau_j = \phi_j$). Summing up, the probability that an infected person is detected and isolated is given by $\iota_j \cdot \phi_j + (1 - \iota_j)\tau_j$.

We assume that recovered agents are immune.¹⁵ Individuals that recover can be released from lockdown at no risk to themselves or others. However, due to imperfect testing, we suppose that only a fraction κ_j of recovered agents are identified as such and allowed to work freely. The remaining fraction is either not identified or treated identically to those that are not deemed recovered. Once again, to simplify we assume this status is determined immediately after recovery.¹⁶

¹³Relaxing this assumption is possible, but requires keeping track of an additional state variable.

¹⁴One may extend the model to incorporate increasing capacity by allowing $\psi_j(H(t), t)$ to depend on t .

¹⁵Although many experts agree that this is currently the leading hypotheses for COVID-19, it is important to stress that, due to the recency of the pandemic, at this time this hypothesis is not backed by conclusive evidence. Indeed, the World Health Organization has stated “There is currently no evidence that people who have recovered from COVID-19 and have antibodies are protected from a second infection.” (April 24, 2020, briefing: <https://www.who.int/news-room/commentaries/detail/immunity-passports-in-the-context-of-covid-19>).

¹⁶If the only constraint were detection, it might be reasonable to suppose $\kappa_j \in [\iota_j \cdot \phi_j + (1 - \iota_j)\tau_j, 1]$ capturing the notion that we do not forget those that were identified as being infected. However, we do not require this condition.

Lockdown and Social Distancing. We now consider lockdown and social distancing measures that affect the rate of transmission of infections. To simplify our discussion we label all of these as “lockdown” policies, although they could represent other social distancing behavior and policies as well.

Workers in group j produce w_j when they are not in lockdown and zero otherwise. The latter is just a normalization: if some production is possible during lockdown, then w_j captures the extra output produced outside of lockdown.¹⁷

Let $L_j(t)$ denote the share of group j that is in “lockdown”, away from work, with $L_j(t) = 1$ designating full lockdown and $L_j(t) = 0$ no lockdown. Intermediate values of $L_j(t) \in (0, 1)$ represent less extreme situations. One interpretation is that at each instant t a random fraction $L_j(t)$ is drawn from group j and sent into lockdown, with the fraction being independently drawn at each moment.¹⁸

Following [Alvarez, Argente and Lippi \(2020\)](#), we assume full lockdown may not be feasible, so $L_j(t) \leq \bar{L}_j \leq 1$. This may capture that some goods are deemed essential, so their production cannot be shut down. Alternatively, it may be hard to monitor and prevent some people from going to their workplace. We also assume that even if full lockdown were feasible, so that nobody can work, it would not necessarily eliminate all human interactions and contagion. In particular, we assume that lockdown $L_j(t)$ reduces actual work by $L_j(t)$, but, as far as contagions, reduces the presence of group j by a factor $1 - \theta_j L_j(t)$ with $\theta_j \leq 1$. This may capture the people are still allowed on the streets and transmission occurs when they cross paths, or it may capture people disobeying lockdowns or quarantines, or cheating at the margin by visiting each other socially. It may also capture transmission that occurs without direct person-to-person contact, as when someone touches an object recently touched by an infected person. Basically, for a number of reasons, lockdown is not fully efficient at removing transmission and $\theta_j < 1$ is a measure of this inefficiency.

Cost of Death (Value of Life). Any analysis studying optimal lockdown policy must confront modeling the cost of death, or, equivalently, the value of life.¹⁹ We approach this

¹⁷Note that w_j summarizes both the wage and employment level of group j . In the data, as people age wages rise but labor participation falls. More generally, w_j may also capture more than production, such as utility benefits experienced by consumers or leisure outside of lockdown, but we focus on the narrow interpretation of this variable to facilitate our quantitative analysis.

¹⁸This implies that intermediate lockdowns are not selecting the same workers to be locked down persistently. These types of policies can be incorporated into our framework by splitting identical workers into different groups that can be treated differently.

¹⁹Correctly interpreted, the economic concept for the value of a statistical life, or the value of life years, is the value of increasing the survival probabilities marginally. The value of a life may be above or below the income lost from life. In general, one could use revealed preference choices over risk of death, but there

issue in a general way by introducing a free parameter χ_j that represents an additional emotional cost of death in group j . This cost is in addition to any lost output from the lost worker. By varying χ_j we will trace out a frontier between output and lives that are saved, and we can explore results that are not dependent on particular values for the value of life.

Cure and Vaccine. We assume a vaccine and cure become available at some date T . To simplify, we assume that a cure for all those currently infected also becomes available at the same date.²⁰ In the case of COVID-19, experts currently estimate the time for developing, testing and rolling out a vaccine to be around 1-2 years, although extraordinary efforts are underway to speed up vaccine developments. We may allow T to be stochastic, but assume no news about T is forthcoming before T .

2.2 Dynamics

Before the vaccine and cure, infections for group j evolve according to the differential equation for all $t \in [0, T)$

$$\dot{I}_j = M_j(S, I, R, L)(1 - \theta_j L_j) S_j \sum_k \beta_{jk} (1 - \theta_k L_k) I_k - \gamma_j I_j,$$

with effective-contact coefficients

$$\beta_{jk} = \rho_{jk} (1 - \iota_k \phi_k - (1 - \iota_k) \tau_k),$$

for given contact coefficients $\rho_{jk} \geq 0$ and

$$M_j(S, I, R, L) \equiv \left(\sum_k \beta_{jk} [(S_k + \eta_k I_k + (1 - \kappa_k) R_k) (1 - \theta_j L_k) + \kappa_k R_k] \right)^{\alpha-2},$$

where $\eta_k = 1 - \iota_k \phi_k - (1 - \iota_k) \tau_k$.

To gain some insight into this key equation, note that if $\alpha = 2$ then $M = 1$ and also R drops out of the equation, so only S and I matter. If in addition we have a single group

is a wide range of estimates depending on the kind of choices that are used to infer the value of life.

²⁰In fact, anti-viral drugs to treat an infection and vaccines require two separate medical advances and implementations. In practice, this simplifying assumption makes little difference as long as infection at date T are low, so that the value of a cure for the currently infected is small relative to the benefit of preventing further infections.

then the equation reduces to

$$\dot{I}_j = \beta SI(1 - \theta L)^2 - \gamma I$$

which is the standard quadratic matching specification adopted by [Atkeson \(2020b\)](#); [Alvarez et al. \(2020\)](#); [Stock \(2020\)](#).

With more than a single group, the coefficients $\{\rho_{jk}\}$ allow for different contact rates across groups. For instance, it may be natural to suppose that $\rho_{jj} > \rho_{jk}$ for $k \neq j$, so that individuals of a given group tend to have a higher contact rate within their own group (i.e., the young may work and socialize with each other more than with the old).

Although much of the literature focuses on the quadratic matching case with $\alpha = 2$, as noted above we allow a more general formulation. For example, the case with $\alpha = 1$ is a matching technology that exhibits constant returns to scale. Doubling S , I and R (while fixing the lockdown policy L) doubles the number of infections, leaving the rate of growth in infections unchanged. In contrast, with quadratic matching, it would quadruple it. Intuitively, the constant returns case with $\alpha = 1$ assumes that the number of contacts for each individual are not affected when the total number of people not in lockdown doubles. In contrast, the quadratic case with $\alpha = 2$ assumes the number of contacts would double in this case. This captures the idea that a more densely occupied environment leads to more contacts. Reality is likely somewhere between these two extremes, so we treat $\alpha \in [1, 2]$ as a free parameter.

One special implication of $\alpha = 2$ is that the number of recovered agents in the population (outside of lockdown) does not affect the number of new infections. In contrast, whenever $\alpha \in [1, 2)$ a greater number of recovered agents lowers the number of new infections. For example, when $\alpha = 1$ what matters is the ratio of infected relative to the entire pool of those that are not in lockdown, so more recovered agents help reduce this ratio. This notion, that recovered agents help protect the susceptible seems appealing to us, but is absent in the quadratic $\alpha = 2$ case. This has implications for the fraction of the population at which herd immunity is reached.

The rest of the laws of motion is for $t \in [0, T)$ given by

$$\begin{aligned}\dot{S}_j &= -\dot{I}_j - \gamma_j I_j \\ \dot{D}_j &= \delta_j^d(H) H_j \\ \dot{R}_j &= \delta_j^r H_j + \gamma_j (I_j - H_j)\end{aligned}$$

where $H_j = \iota_j I_j$ denote the number of ICU patients in groups j and $H = \sum_j H_j$ denotes

the total.

The equations above describe the dynamics before T . After the vaccine and cure arrives we have $I(t) = 0$ and $R(t) = S(T_-) + R(T_-)$ and $D(t) = D(T_-)$ for $t \geq T$. Naturally, we can set lockdowns to zero, $L(t) = 0$, for all $t \geq 0$.

Employment is given by

$$E_j(t) = (1 - L_j(t))(S_j(t) + (1 - \iota_j\phi_j - (1 - \iota_j)\tau_j)I_k(t) + (1 - \kappa_j)R_j(t)) + \kappa_j R_j(t).$$

Note that lockdown enters asymmetrically in employment relative to the infections equation: it is $(1 - L_k)$ that determines employment, but it is $(1 - \theta_k L_k)$ that determines the number of new infections.

An Aggregation Result. Before moving on, we point out that our MR-SIR model displays a nice aggregation property, behaving like a single group SIR model in special cases.

Suppose that effective contact rates and resolution rates out of infection the same across groups, so that $\beta_{jk} = \beta$ and $\gamma_j = \gamma$, and consider lockdown policies that are uniform across groups as well, so that $L_j(t) = L(t)$ for all j . Suppose further that infection rates are initially identical across groups, so that $S_j(0)/N_j$, $I_j(0)/N_j$ and $R_j(0)/N_j$ are independent of j . Then it is straightforward to see that, despite differences in fatality rates, the evolution of infections within each group, and hence aggregate infections, is identical to that of a single group SIR model. The same is not true for deaths—these are different across groups but do not affect the evolution of infections.

2.3 Planning Problem

Our planner controls $\{L_j(t)\}_j$ for all $t \in [0, T)$ taking the dynamical system described above. We next describe the objective function.

Deterministic Vaccine Arrival. The objective is to minimize the expected present value social cost

$$\int_0^\infty e^{-rt} \sum_j (w_j(N_j - E_j(t)) + \chi_j \delta_j^d(t) \iota_j I_j(t)) dt$$

The term $\chi_j \iota_j \delta_j^d(t) I_j(t)$ captures the non-pecuniary costs of deaths, since the flow of death is given by $\delta_j^d(t) \iota_j I_j(t)$. Note that even though the vaccine arrives at T , earlier deaths have a permanent impact on $E_j(t)$ and thus affect the integrand for $t \geq T$. However, after

integration-by-parts we can write the objective as

$$\int_0^T e^{-rt} \sum_j \Psi_j(t) dt, \quad (1)$$

where the flow cost for group j is given by

$$\Psi_j(t) = w_j S_j(t) L_j(t) + w_j I_j(t) (1 - \eta_k (1 - L_j(t))) + w_j (1 - \kappa_j) R_j(t) L_j(t) + \hat{\chi}_j t \delta_j^d(t) I_j(t)$$

where $\hat{\chi}_j = \frac{w_j}{r} + \chi_j$ represents the total cost of a death. Note that the integral now integrates only over a finite horizon up to T .

Stochastic Vaccine Arrival. Allowing the vaccine arrival time to be stochastic is simple. Suppose T has cumulative distribution $F(T)$ and assume there is no information about the vaccine arrival before its arrival. Then the objective can be shown to equal

$$\int_0^\infty (1 - F(t)) e^{-rt} \sum_j \Psi_j(t) dt$$

Previously $1 - F(t) = 0$ for $t < T$ and $1 - F(t) = 0$ for $t \geq T$. Note that this last expression coincides with [Alvarez et al. \(2020\)](#) for the single group case when $r_j = 1$, $\eta_k = 1$ and a Poisson distribution $1 - F(t) = e^{-\nu t}$ with arrival $\nu > 0$.

Marginal Value of Vaccine Innovations. Suppose we have a marginal improvement in the arrival distribution $F(t)$, so that $F(t)$ rises at all values of t . For example, if the vaccine was arriving deterministically, we may consider a change $dT < 0$.

Consider a marginal changes δF in the distribution. Applying the Envelope Theorem, we compute the marginal change in the planner objective to be:²¹

$$\int_0^\infty -\delta F(t) e^{-rt} \sum_j \Psi_j(t) dt$$

As usual, the planner will react to a change in F to achieve a new optimum, but the Envelope Theorem allows us to evaluate the marginal value of small changes without computing the change in the solution. Intuitively, when the vaccine arrives earlier, the

²¹This calculation presumes the solution is continuous in the arrival c.d.f. F at the original optimal point. Because the problem is not convex, solutions may be discontinuous. If the solution is discontinuous, a similar formula holds for the directional derivative.

distribution of $F(t)$ shifts up, lowering the cost because the future flow costs from lock-down, represented by integrand, are no longer incurred.

Note that the marginal value of innovations in vaccines depends crucially on lock-down and infection rates. For example, if both are vanishingly small wherever $\delta F(t) \neq 0$, then there is only a vanishingly small improvement. Intuitively, if the original solution is “going for herd immunity”, then a slightly earlier vaccine arrival is of little value.

The special case where the vaccine arrives deterministically at T and we consider a change dT gives a change in value

$$-dT \cdot e^{-rT} \sum_j \Psi_j(T).$$

3 A Simple Specification and Calibration

In our analysis in the remainder of the paper, we focus on targeting policies based on age.²² Here, as a first exercise, we focus on just a few parameters, and thus simplify the model in various ways.

We consider a setting with three groups, the “young” (y) who are ages 20-49, the “middle-aged” (m) who are 50-64, and the “old” (o) who are 65 and above. We do not include those under 20 in our analysis. We take the population share of these three groups among those over 20 years of age from BLS population data for 2019, setting $N_y = 0.53$, $N_m = 0.26$, and $N_o = 0.21$. In our baseline, we assume that the old are retired and thus set $w_o = 0$.²³ We assume equal earnings per capita for the young and middle-aged groups, which we normalize by setting $w_y = w_m = 1$.²⁴

As in [Alvarez, Argente and Lippi \(2020\)](#), in our baseline calibration we set $\bar{L} = 0.7$ when we consider uniform policies, and set $\bar{L}_o = 1$ and $\bar{L}_j = 0.7$ for the other groups when considering targeted policies. We also follow their paper and assume that there is no testing and isolation of those who are infected (even those requiring medical care), so that $\phi_j = \tau_j = 0$, while there is perfect identification of those individuals who have recovered and can safely go back to work, so that $\kappa_j = 1$. These testing parameters are

²²Another factor that targeted policies could depend on is the presence of co-morbidities, which have been shown to lead to significantly higher mortality and ICU needs.

²³In reality, about 20% of those over 65 are employed (33% of those 65-69, 19% of those 70-74, and 9% of those 75 and above) versus 78% of those 20-49 and 68% of those 50-64. We verify in our robustness checks that using these higher numbers for the “wage” of the older group does not change our main conclusions, since it remains optimal to keep this group under a severe lockdown.

²⁴From BLS statistics, for those employed full time, the middle-aged have 12% higher weekly earnings, but are 13% less likely to be employed. The share of workers who are employed full-time versus part-time is roughly equal in the two groups.

Age Group	Mortality rate $\underline{\delta}_j^d$
20-49	$0.001 \times (1/18)$
50-64	$0.01 \times (1/18)$
65+	$0.06 \times (1/18)$

Table 1: Mortality Parameters from COVID-19.

likely to have an important effect on optimal policies, but other than a preliminary look in subsection 4.5, we defer that issue to future analysis.

We assume that a COVID-19 case reaches a conclusion, with the individual either recovering or dying, in 18 days on averages, giving $\gamma = 1/18$.

For the nature of interactions we start by assuming that there is a single pool in which all of those who are not effectively locked down (share $(1 - \theta L_j)$ of each group j) interact. We examine various values of θ in our analysis. We set

$$\rho_{ij} = \begin{cases} \bar{\beta} & i = j \\ \bar{\beta}\rho & i \neq j \end{cases}$$

In our baseline we set $\rho = 1$. We then consider the case in which the intra-group matching is lowered so that $\rho < 1$. We set $\bar{\beta}$ equal to 0.2, reflecting common estimates of the value of R_0 (which is the ratio $\bar{\beta}/\gamma$ of the number of new infections generated in a day by an infectious individual when the whole population is susceptible to the daily probability of an infectious case’s resolution) without social distancing and isolation measures.

We set base daily mortality rates $(\underline{\delta}_y^d, \underline{\delta}_m^d, \underline{\delta}_o^d)$ for an infected individual described in Table 1 to roughly match mortality rates used by Ferguson et al. (2020) and that reflect the 18 day illness duration: For the young and middle-aged groups, these numbers closely match mortality rates we derived from recent South Korea data, a country with ample ICU capacity relative to needs and widespread testing (and thus hopefully relatively little selection of the more seriously ill among those tested).²⁵ For those over 70, however, the South Korean data give a much higher fatality rate than that used by Ferguson et al. (2020). Given even lower fatality rates for older cohorts from the *Diamond Princess* cruiseship, we opted to use mortality rates close to Ferguson et al. (2020) for those ages 65+ as our baseline and then verified the robustness of our results to Korean rates.

²⁵We used age-specific deaths reported on April 11 and divided by the total number of age-specific cases reported 18 days earlier. The data are available in the Korean language press releases of the Korean Central Disease Control Headquarters & Central Disaster Management Headquarters: <http://ncov.mohw.go.kr/tcmBoardList.do?brdId=3>

Finally, we model the effect of the population infection rate on mortality due to limited hospital capacity by assuming that ICU needs are proportional to these base mortality rates, setting $\iota_j = \sigma \delta_j^d$ for some parameter $\sigma > 0$.²⁶ Hence, ICU needs at time t are $H(t) = \sigma \sum_k \delta_j^d I_k(t)$. We then specify that, for some parameter $\lambda > 0$,

$$\begin{aligned}\delta_j^d(t) &= \delta_j^d \cdot [1 + \lambda H(t)] \\ &= \delta_j^d \cdot [1 + \hat{\lambda} \sum_k \delta_k^d I_k(t)]\end{aligned}$$

where $\hat{\lambda} = \lambda \sigma$. It is difficult to know how high mortality rates would go if ICU needs massively exceeded available capacity. We set $\hat{\lambda}$ such that if there is a 30% infection rate in the overall population, then mortality rates are 5 times the base mortality rates.²⁷

We adjust the value of life to reflect finite working horizons and also include a constant non-pecuniary value of life, χ . In equation (1) the total cost of death is given by $\hat{\chi}_j = \frac{w_j}{r} + \chi_j$, with the $\frac{w_j}{r}$ term reflecting the infinite worklife into the future. In our calibration, we adjust this factor to account for the differential working horizons for the different groups j . Specifically, we choose χ_j such that $\chi_j = \chi - \frac{w_j}{r} e^{-r\Delta_j}$ where Δ_j represents remaining work time for group j . We set $\Delta_y = 15 \times 365$ and $\Delta_m = 7.5 \times 365$. In what follows, we interpret $\frac{w_j}{r} (1 - e^{-r\Delta_j})$ as the pecuniary cost of a death, while χ is the non-pecuniary cost.

Finally, in our baseline we treat the arrival time of the vaccine, T , as deterministic. We have experimented with some specifications including uncertainty, such as Poisson arrival rates with mean arrival times of 1 or 1.5 years, and the results are very similar. We prefer deterministic arrival times as our baseline, since these make it easier to interpret our solution. For example, with deterministic T it is easier to judge whether the solution is attempting to avoid infections and hold out for the vaccine or giving up on this and going for herd immunity before its arrival.²⁸ Specifically, we suppose that a vaccine will arrive in one and a half years, and so set $T = 548$ days, and let the daily interest rate be $r = .01/365$.

²⁶The Korea data, which report the numbers of current “critical” and “severe” active cases, provide some support for this assumption.

²⁷Alvarez, Argente and Lippi (2020) also assume that mortality rates increase five-fold at the highest possible peak of infections.

²⁸We have also experimented with a Poisson specification with mean arrival time of 1-1.5 year and it does not alter substantially the quantitative results presented below.

4 Optimal Policies

In this section we present our main quantitative results for the baseline parameter values described in the previous section. Throughout our main focus is on the comparison between optimal uniform policies (where all three age groups are treated uniformly), optimal semi-targeted policies (where the oldest age group is treated differently than the young and middle-aged groups) and optimal fully-targeted policies (where policy is fully heterogeneous by group). The main message from our baseline results in the next subsection is that targeting has a major benefit in terms of both lives saved and reduced economic damage relative to optimal uniform policies, and interestingly, most of this benefit can be achieved with the semi-targeted policies. The rest of the section investigates how the comparison between these different types of policies changes when we modify some of the key parameters. We emphasize, in particular, that whether different age groups can be partially isolated from each other and the form of the matching technology are both important, but the relative performance of the different types of policies is scarcely affected by these variations. Reducing the arrival time of a vaccine has more major effects, since it changes the form of optimal policies towards longer lockdowns in order to wait for the vaccine. Nevertheless, targeted policies again perform much better than uniform policies. We also investigate the effects of the ability to test and isolate the infected, and show that successful testing and isolation of infected individuals leads to large improvements in outcomes but does not alter our main results about the value of targeted policies. We also report a range of other robustness results.

4.1 Baseline Results

Figure 4 depicts the optimal uniform policy and its implications for infections, economic loss and fatalities for our baseline parameter values. In this baseline we have $\alpha = 2$, so that the matching technology is quadratic; $\rho = 1$ so that, absent differential lockdowns, individuals match with members from their group and different groups at the same rate; $\theta = 0.75$ for all groups so that a full lockdown will be disobeyed a quarter of the time; $T = 548$, so that the vaccine will arrive in one and a half years time; and $\chi = 20$, which implies that the non-pecuniary cost from a lost life is equal to 20 times the annual economic contribution of a typical individual. Throughout, we take the initial conditions of the dynamical system to be 98% susceptible, 1% infected and 1% recovered within each group.

Figure 4 depicts the optimal uniform policy (which applies the same lockdown to all three groups). It shows a relatively lengthy lockdown that starts at around 0.6 and

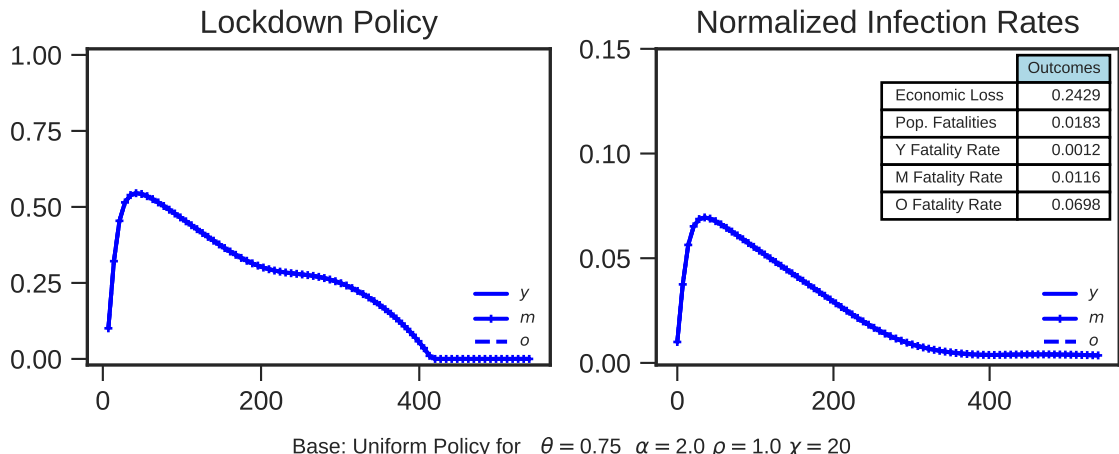

Figure 4: Optimal uniform policy for baseline.

then is gradually reduced, reaching (essentially) a full release of all workers only on day 434. This form of policy is similar to optimal policies in other SIR models fitted to the COVID-19 parameters and that assume a sufficiently large value of life. Consistent with our aggregation result, the figure shows that the overall infection rate peaks around 6% early on and follows the hump-shaped pattern typical in SIR models. As documented in the table within the figure, fatalities are high with a relatively large economic cost. Total fatalities are 1.83% of the population. The economic cost is 24.3% of one year’s GDP (this number includes the economic loss from the forgone future contributions of those who die but excludes the non-pecuniary cost captured by χ ; if we only look at decline in current GDP, the loss would be 19.3%). By comparison, no lockdown results in a peak infection rate over 30%, fatalities equal 5.44% of the population, and an economic loss of 14.4% of one year’s GDP (in this case, all due to lost future output from workers who die).²⁹

Figure 5 turns to the optimal semi-targeted policy for the same parameter values. Recall that this policy targets a different policy for the retired older group than for the working age groups (young and middle-aged). Since the oldest group has no economic contribution in our baseline parameterization, it is optimal to have a strict lockdown for them throughout. We can also see that the other two groups now experience a less severe and shorter lockdown. This represents a combination of waiting for a vaccine but with some elements of partial herd immunity—the right panel indicates a higher peak infection rate for the young and middle-aged groups than in the full uniform policy, reaching over 11% at the early stages and then declining rapidly thereafter, combined with a lower infection

²⁹The costs of the no lockdown policy may be lower than this in practice because of social distancing measures taken by individuals themselves in the absence of lockdowns.

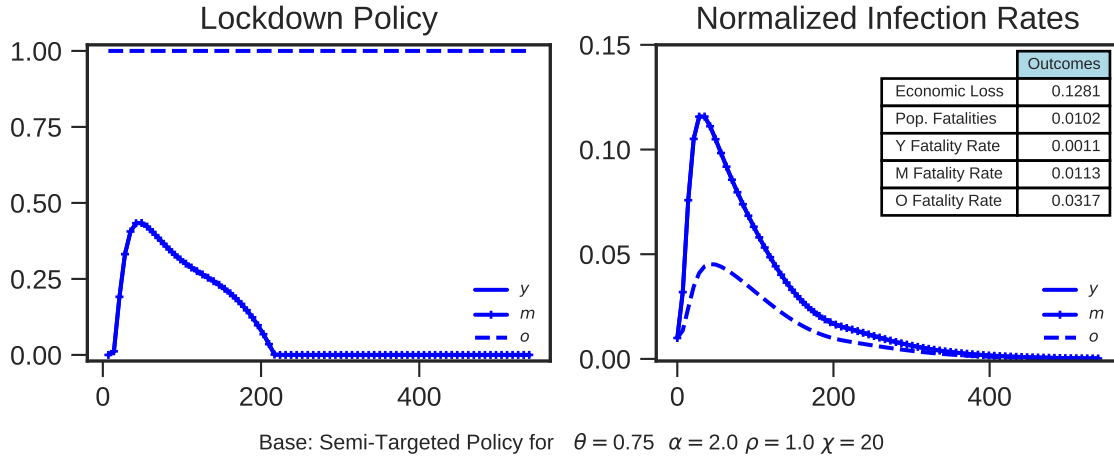

Figure 5: Optimal semi-targeted policies for baseline.

rate for the oldest group, who remain locked down until the vaccine arrives.³⁰³¹ The reason why the old are experiencing a 4% peak infection rate is because their lockdown is not fully enforceable—as captured by $\theta = 0.75$. Despite the much less severe lockdown for the majority (79%) of the population who are young or middle-aged, fatality rates are lower. This is because the older group, which has the highest risk from the infection, is kept locked down throughout the non-vaccine period, and the younger groups have lower risk, so their higher infection rates do not lead to much higher fatalities. The table in the figure shows that, now, the overall fatalities have fallen approximately 45% to 1.02% of the population. There is a sizable reduction in economic damages as well, from 24.3% of one year’s GDP under uniform policies to 12.8% under the semi-targeted policy.

Figure 6 depicts the optimal fully-targeted policy, again for the same parameter values. The oldest group is once more fully locked down for the duration of the non-vaccine period, while the other two groups are put under a less severe lockdown, so that the overall form of optimal policy is once more a mixture of waiting for the vaccine and partial herd immunity for the younger groups. Specifically, in this case, the youngest group has a very limited lockdown, starting with only 30% of their cohort being subject to lockdown and with these restrictions being lifted very rapidly, while the middle-aged group experiences a more extensive lockdown than under the semi-targeted policy (but much less than the uniform policy). This difference notwithstanding, the overall performance of the optimal

³⁰We refer to this pattern as “partial herd immunity” because infections come down without a vaccine, but this is only because the older group is kept in lockdown.

³¹Despite this high peak infection rate, the overall fatality rate among younger groups is essentially the same under semi-targeted and uniform policies—namely, the respective fatality rates among the young and the middle-aged change from 0.1% and 1.2% under the optimal uniform policy to 0.1% and 1.3% under the optimal semi-targeted policy.

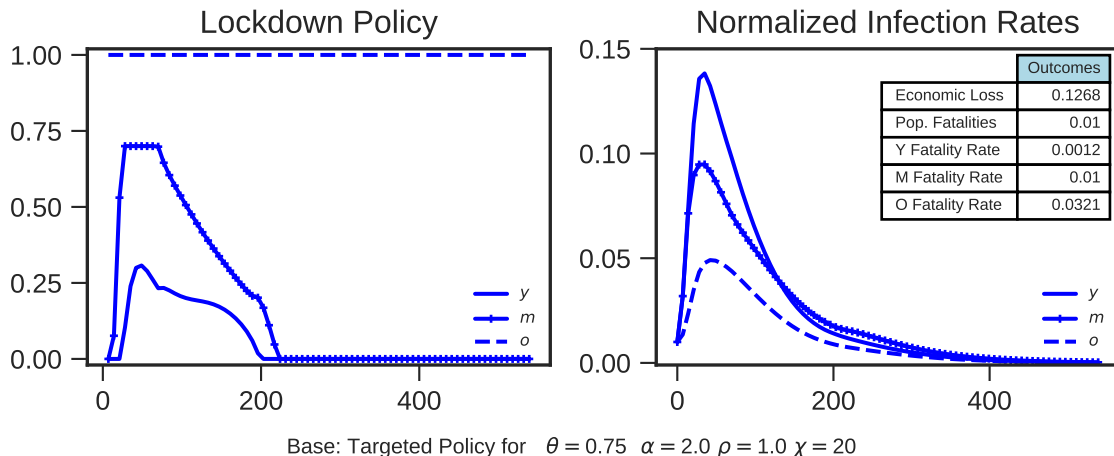

Figure 6: Optimal fully-targeted policies for baseline.

fully-targeted policy is very similar to that of the optimal semi-targeted policy: overall fatalities are 1.00% of the population and there is a loss of 12.7% of one year’s GDP. This similarity between the semi-targeted and fully-targeted policies is a recurrent theme of our results and reflects two features. First, the big social gain is from locking down the oldest group, which has no (or in our robustness checks limited) economic contribution but is most vulnerable to the infection. Once this is achieved, the additional targeting has more limited benefits. Second, additional targeting makes the middle-aged group stay home for longer and the younger group go to work sooner. The fatality and economic effects of these two opposing changes are small.

The previous three figures presented the optimal policy for a specific value of χ . Figure 7, instead, depicts the frontier between lives lost and economic damages under different policies, by tracing out the implied optimal policies and their implications for different values of χ . As in Figure 1 in the Introduction, the bliss point in this figure is the origin, where there are no lives lost and no economic damage. Each curve represents the frontier arising under a different class of policies: the top (red) frontier is for uniform policies, then below it (green) is the frontier for semi-targeted policies, and slightly below this (in blue) is the frontier fully targeted policies. The convex shape of the frontiers represents the diminishing returns to pursuing one objective at the expense of the other.³² The point at the southeast end of the frontier for a given class of policies represents the policy outcome that maximizes GDP in that class. For example, the GDP-maximizing outcome with a uniform policy results in a 3.86% fatality rate and an economic loss of 13.0% of one year’s GDP, which dominates the uncontrolled outcome in which 5.44% of the population dies

³²Note, however, that we are computing nine points and constructing the frontier by interpolating between them.

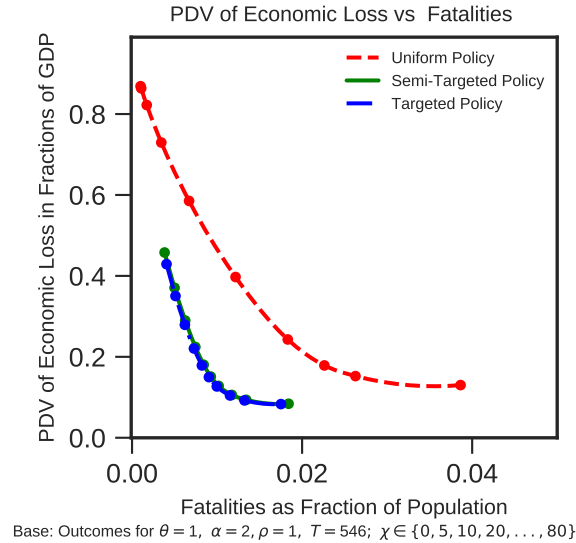

Figure 7: Frontiers of output loss vs. death for baseline specification for different levels of targeting.

and the economic loss is 14.4% of one year’s GDP.

This figure confirms the main message from Figures 4, 5 and 6: there are substantial gains from semi-targeting (because we are locking down the most vulnerable subpopulation) and considerably smaller gains from full targeting (in fact, the blue frontier for the fully-targeted policy is only slightly to the left of the green frontier for the semi-targeted policy). The frontier presented in Figure 7 also enables us to illustrate how targeted policies can reduce lives saved without any worse economic outcomes. For example, by adopting a semi-targeted policy we can keep economic damages the same as the 24.3% GDP decline we obtained above with an optimal uniform policy, but reduce the fatality rate of the (adult) population from 1.83% to approximately 0.71%. This would amount to 2.7 million lives saved out of the 241 million US adult (over 20) population because of better designed lockdown policy. The same reduction in fatalities could be accomplished using a uniform policy, but only by increasing the economic loss from 24.3% of one year’s GDP to approximately 57.2%.

The policies we described in Figures 4, 5 and 6 are optimal when the non-pecuniary cost of death equals $\chi = 20$. As Figure 7 makes clear, the gains from targeting depend on the location on the frontier, which depends on χ . As $\chi \rightarrow \infty$ full lockdown becomes optimal and there are no gains from targeting, but even for very large values of χ semi-targeted policies do much better than uniform policies.³³

³³For example, if $\chi = 100$, a semi-targeted policy could generate the same GDP loss as the optimal uniform policy, while reducing deaths by approximately 120,000.

4.2 The Role of Group Distancing

Our model with different risk groups enables us to investigate the implications of policies that reduce inter-group interactions. In our baseline parameterization, individuals are assumed to match others from their group and other groups at the same rate, leading to the common infection rate $\bar{\beta}$, absent any lockdowns. A natural alternative is to assume that matches between groups can be reduced, say by a fraction $1 - \rho$, so that the infection rate from between-group matches is reduced to $\bar{\beta}\rho$. Our baseline parameterization is the case with $\rho = 1$. There are various policy tools for achieving such reductions, such as norm-based interventions (so that people visit their elderly relatives less often) or law-based interventions (e.g., allowing the oldest age group to go to supermarkets and pharmacies only during certain hours or restricting who can visit and work in nursing homes).³⁴

Figure 8 presents the optimal policies (again for $\chi = 20$) when ρ is reduced to $\rho = 0.5$. There is once more a long lockdown, even if it now ends somewhat earlier before the arrival of the vaccine than when $\rho = 1$. Because there are fewer matches between groups, the fatality rate declines (1.34% of the population), and the reduced length and severity of the lockdown keeps economic damage to 17.6% of one year's GDP. Reiterating our main message, the figure shows that we can improve both social objectives significantly by going to semi-targeted policies. Now there is a much shorter lockdown, which peaks in about 30% of the young and middle-aged population being locked down around four months into the spread of the virus and comes to an end completely in about six months. The optimality of these reduced lockdowns for the young and middle-aged arise because of the lower risk they impose on the old: this leads to higher peak infection rates among the young and middle-aged than in our baseline (reaching as high as 12% for the youngest group), but because the oldest group, which is most vulnerable, is kept comparatively more isolated, away from these younger groups, the overall fatalities are much lower, amounting to 0.63% of the population (as compared to about 1% with the targeted policies but uniform matching rates between groups). Economic damages are also kept to 8.0% of one year's GDP.

The figure also shows the optimal fully-targeted policy, which as usual differs from the semi-targeted one (in particular, involving a much stricter early lockdown on the middle-aged), but the gains it produces relative to the semi-targeted optimal policy are again relatively small. Figure 9 depicts the three frontiers in this case and confirms these con-

³⁴With our baseline quadratic matching technology, any change in between-group matching will influence the total number of matches and do so in ways that depend on group size. With the interventions we have in mind, we believe this is the right type of variation to consider, though it should be borne in mind that reduced number of matches will directly decrease infection rates as well.

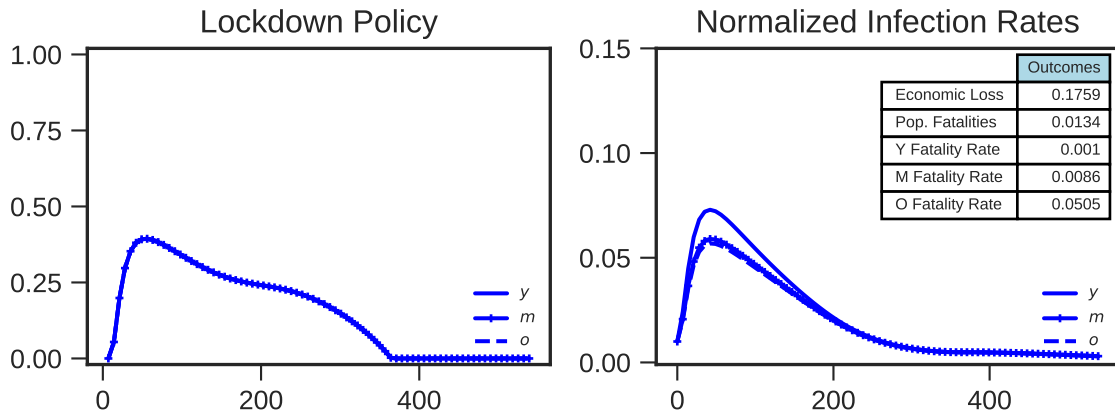

CS1: Uniform Policy for $\theta = 0.75$ $\alpha = 2.0$ $\rho = 0.5$ $\chi = 20$

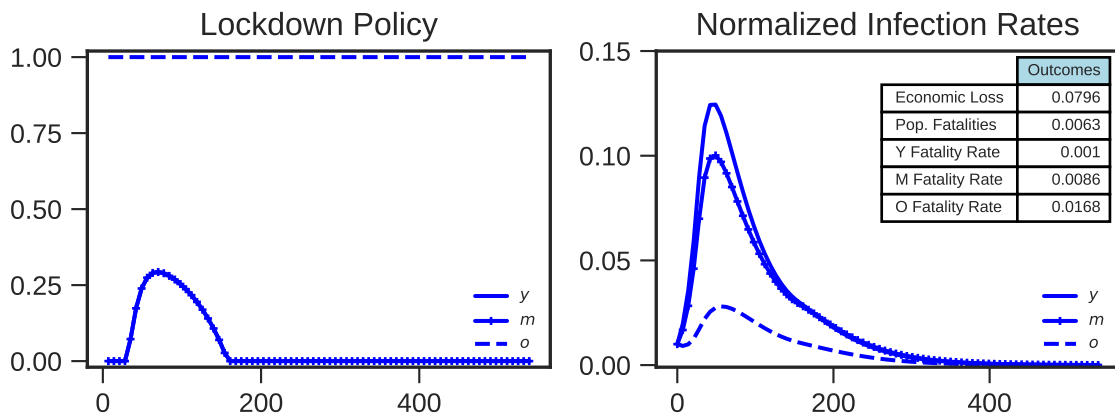

CS1: Semi-Targeted Policy for $\theta = 0.75$ $\alpha = 2.0$ $\rho = 0.5$ $\chi = 20$

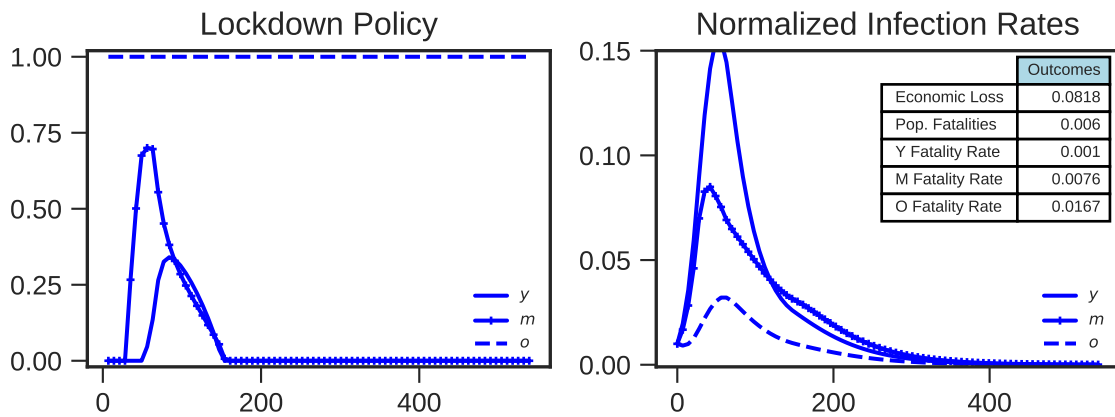

CS1: Targeted Policy for $\theta = 0.75$ $\alpha = 2.0$ $\rho = 0.5$ $\chi = 20$

Figure 8: Optimal uniform, semi-targeted and fully-targeted policies with greater group distancing.

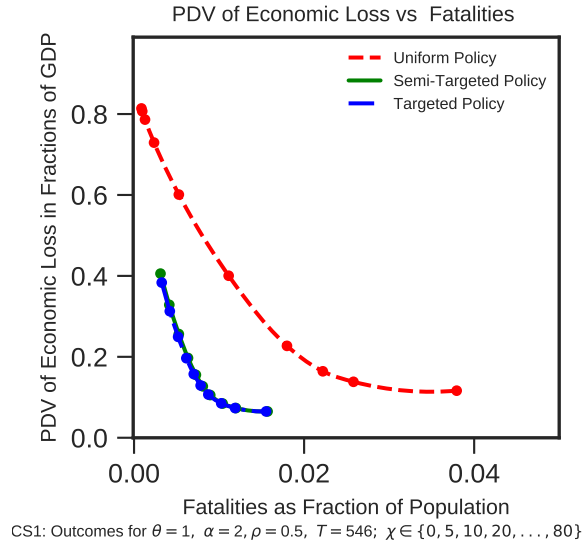

Figure 9: Frontier of output loss vs. death with greater group distancing.

clusions.

The overall message from this subsection is that, if it is feasible to reduce interactions between high-risk groups and the rest of society with policies similar to those used for lockdown, then fatality rates can be reduced significantly and optimal targeted policy can allow both a faster economic recovery and one that is less risky in terms of its public health consequences.

4.3 The Role of the Matching Technology

As noted in the Introduction, our baseline model follows the epidemiology literature (and a number of recent economics papers) in assuming quadratic matching. As in other economic settings, there are reasons why high numbers of individuals may generate congestion (especially when extreme lockdowns are not in effect) and thus reduce matching to rates less than those implied by a quadratic technology. Moreover, while quadratic technology is attractive when matching happens randomly in a geographic space, it is less natural when individuals interact in a given workplace or with their close friends and relatives. It is therefore useful to understand what the implications of departing from this quadratic benchmark are. Another important reason for considering richer matching technologies is that the strong form of “herd immunity” where immune individuals protect the susceptible from infections does not take place with quadratic matching because the matching rate between any two subpopulations is independent of the presence or absence of others in the population (and, specifically, the recovered).

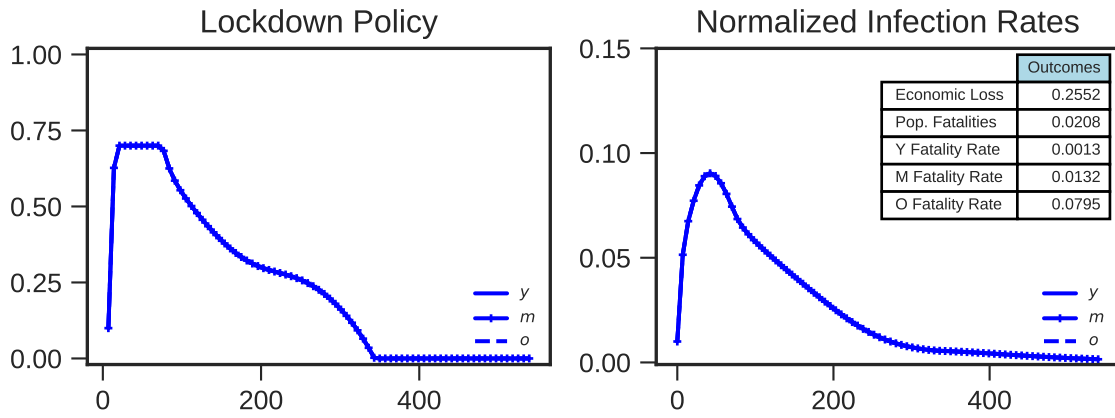

CS2: Uniform Policy for $\theta = 0.75$ $\alpha = 1.0$ $\rho = 1.0$ $\chi = 20$

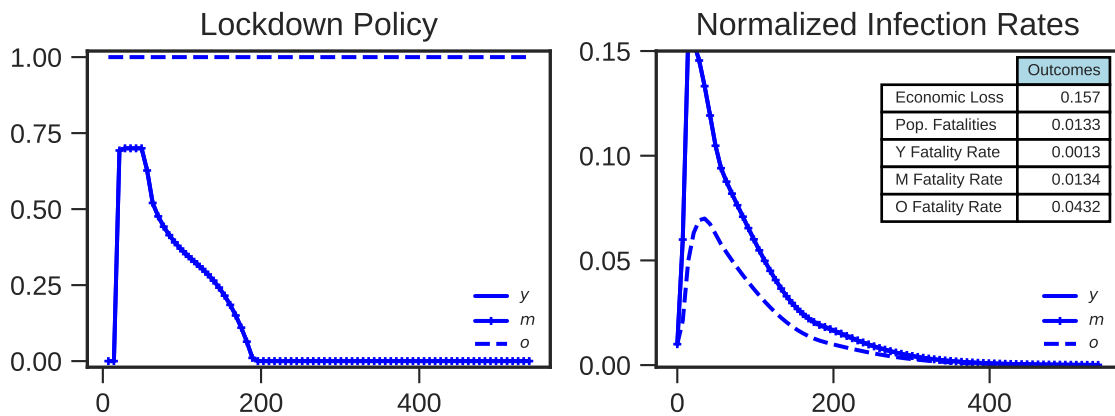

CS2: Semi-Targeted Policy for $\theta = 0.75$ $\alpha = 1.0$ $\rho = 1.0$ $\chi = 20$

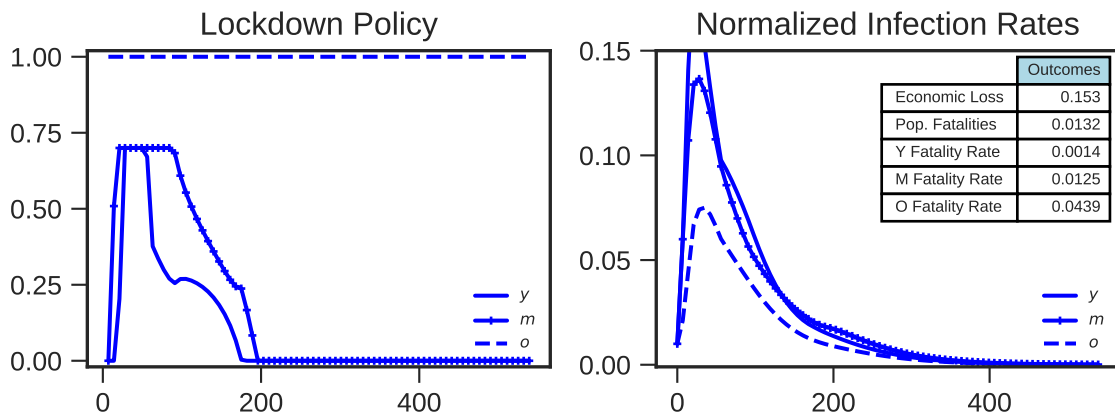

CS2: Targeted Policy for $\theta = 0.75$ $\alpha = 1.0$ $\rho = 1.0$ $\chi = 20$

Figure 10: Optimal uniform, semi-targeted and fully-targeted policies with constant returns matching.

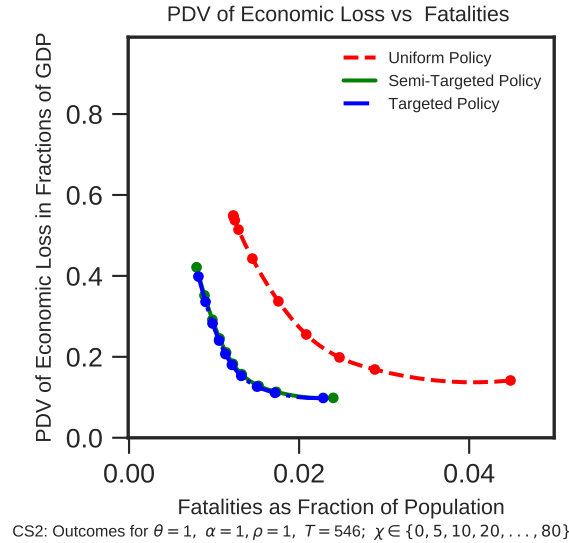

Figure 11: Frontier of output loss and deaths with constant returns matching.

To highlight the role of the matching technology we now present optimal policies when the matching technology has constant returns to scale ($\alpha = 1$).³⁵ Figure 10 shows the optimal policies in this case. Because herd immunity becomes more attractive with $\alpha = 1$, the lockdown with uniform policy is now shorter than in Figure 4, ending around day 350, but is more intense, with the infection rate in the population peaking at 8%. Total fatalities are 2.08%, while economic losses are 25.5% of one year’s GDP.³⁶

The figure once again shows significant improvements when we treat different age groups differentially. With just semi-targeted policies, we can reduce fatalities to 1.33% and economic damages to 15.7% of one year’s GDP. Figure 11 shows the frontiers for the three types of policies, and highlights that there are major gains from targeting.

4.4 The Promise of a Vaccine

In this subsection, we consider the implications of an earlier arrival date for the vaccine. Namely, we reduce T from one and a half years to one year. Figure 12 shows that when a uniform policy is followed, it is now optimal to have a much more aggressive “wait-for-the-vaccine” strategy. The entire population is locked down at about 60% intensity almost until the arrival of the vaccine. This is intuitive: when we expect the vaccine to

³⁵We focus on constant returns to scale matching to clarify the contrast with quadratic matching. In practice, increasing returns to scale between these two may be more plausible, but we currently lack sufficient evidence to pin down the exact matching technology for COVID-19.

³⁶These costs are a somewhat higher than in our baseline specification because, for any S and I , infections are mechanically higher in the constant returns case than in the quadratic case.

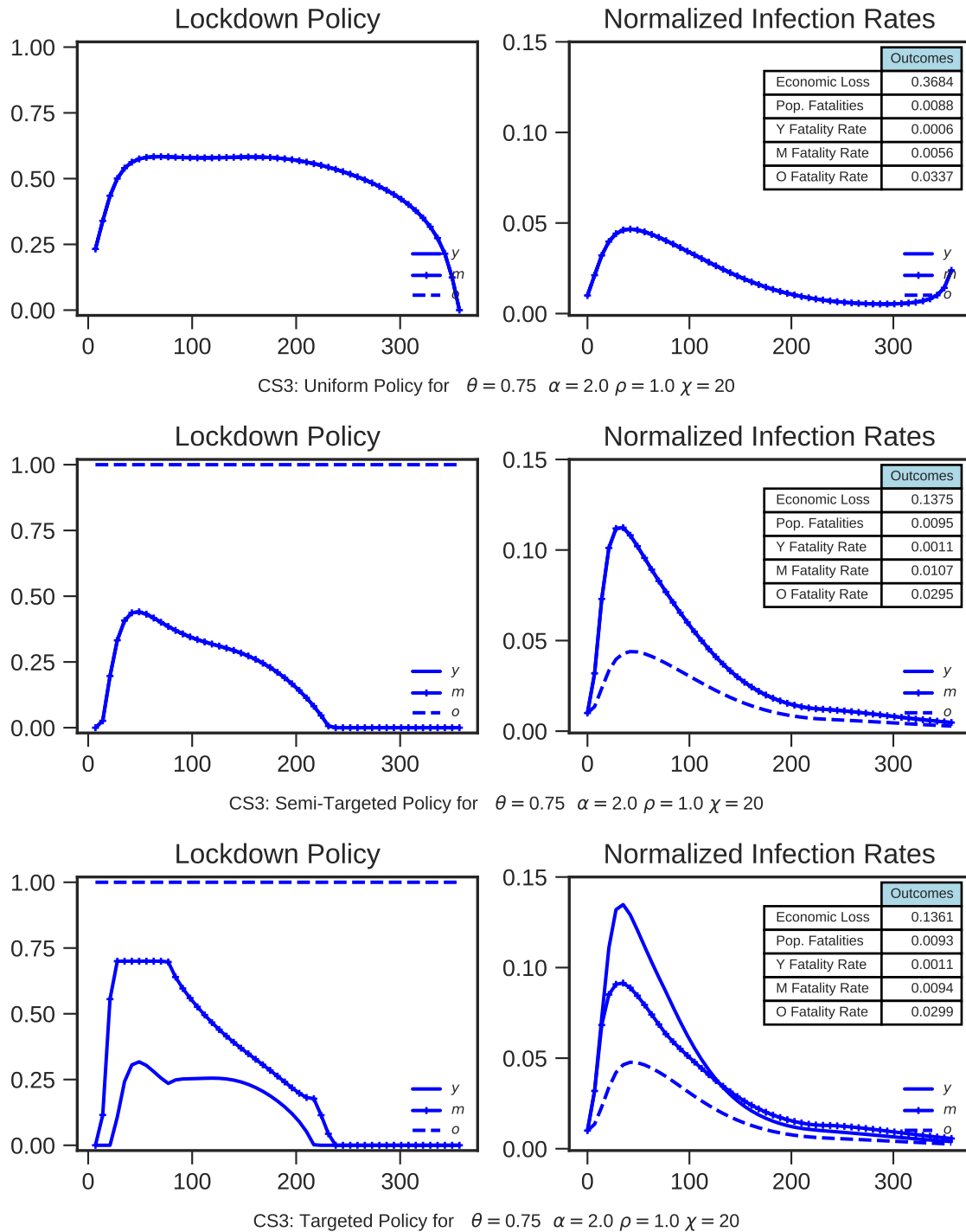

Figure 12: Optimal uniform, semi-targeted and fully-targeted policies with earlier vaccine arrival.

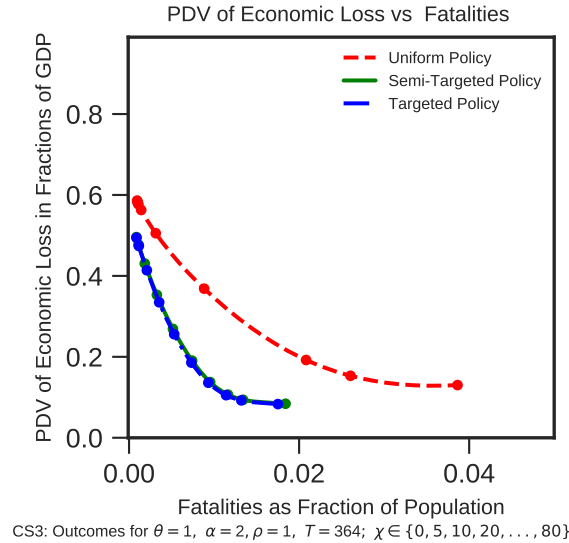

Figure 13: Frontier of output loss and deaths with earlier vaccine arrival.

come soon, we prefer to have less of the population exposed to the virus, favoring a more strict and longer lockdown. As a result, the peak infection rate is lower, just a little under 5% in the entire population. With more aggressive lockdown, fatalities are kept to 0.88% of the population.

The figure illustrates that, even in this case, there are significant gains from more targeted policies. In this case, the “wait-for-the-vaccine” strategy is tempered and the younger groups are allowed to return back to work sooner despite this imminent arrival of the vaccine. This leads to higher fatalities in the population (about 0.95% as compared to 0.88% with uniform policy), but economic damages are significantly lower—13.8% of one year’s GDP (compared to 36.8% with a uniform policy). The economic losses and fatalities with full targeting are similar.

The frontier in Figure 13 shows the trade-off facing policymakers in this case and indicates that, instead of the optimal targeted policies, which result in slightly higher fatalities than the optimal uniform policy, we can find a semi-targeted policy that dominates the optimal uniform policy, for example, achieving a fatality rate of 0.51% with economic losses equal to 26.9% of one year’s GDP.

4.5 The Effects of Testing and Tracing

We next investigate how the ability to test and isolate infected individuals affects optimal policies and outcomes. We consider one case in which the probability that an infected individual is identified and isolated is 0.4, and another case in which it is 0.6. The former

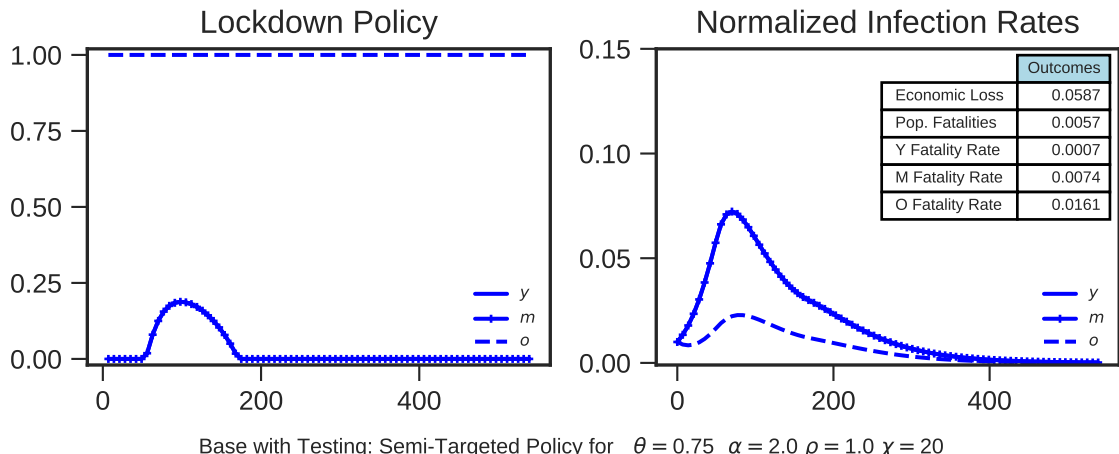

Figure 14: Optimal semi-targeted policies with improved testing and isolation.

is about what we might expect if everyone who is symptomatic is isolated.³⁷ The latter corresponds to a situation where, thanks to testing and contact tracing, there is an additional 1/3 chance that an asymptomatic individual is immediately isolated. We keep all other parameters at the levels in our base specification.

Figure 14 shows the semi-targeted optimal policy when the probability that an infected individual is identified and isolated is 0.4. The lockdown for the young and middle-aged is now much less strict than the baseline (it has about half of the intensity and half of the duration of the optimal semi-targeted policy in the baseline). Resulting fatalities are 0.57% compared to 1.02% in our base semi-targeted specification, while economic loss is 5.9% of a year’s GDP compared to 12.8% before.

Raising the probability that an infected individual is identified and isolated to 0.6 results in further dramatic reductions in economic loss and lives saved (not depicted): the economic loss with an optimal semi-targeted policy is now only 1.2% of a year’s GDP, while fatalities fall to 0.21% of the population. Notably, in this case, the semi-targeted policy has no lockdown for the young and middle-aged.

It is also worth emphasizing that, as before, in both cases the semi-targeted policy yields large gains compared to the optimal uniform policy, and the additional gain from full targeting is small. In particular, the optimal uniform policy leads to a 1.28% fatality rate and an economic loss of 16.6% of one year’s GDP when the probability is 0.4, and to a 0.73% fatality rate and an economic loss of 8.4% when this probability is 0.6.

Finally, Figure 15 shows the optimal semi-targeted policy when there is both social distancing between groups $\rho = 0.5$ and improved testing and isolation (with testing and

³⁷This number is based on the following reasoning: approximately 50% of infected individuals are assumed to be asymptomatic and it takes 5 days for the remaining 50% to exhibit symptoms.

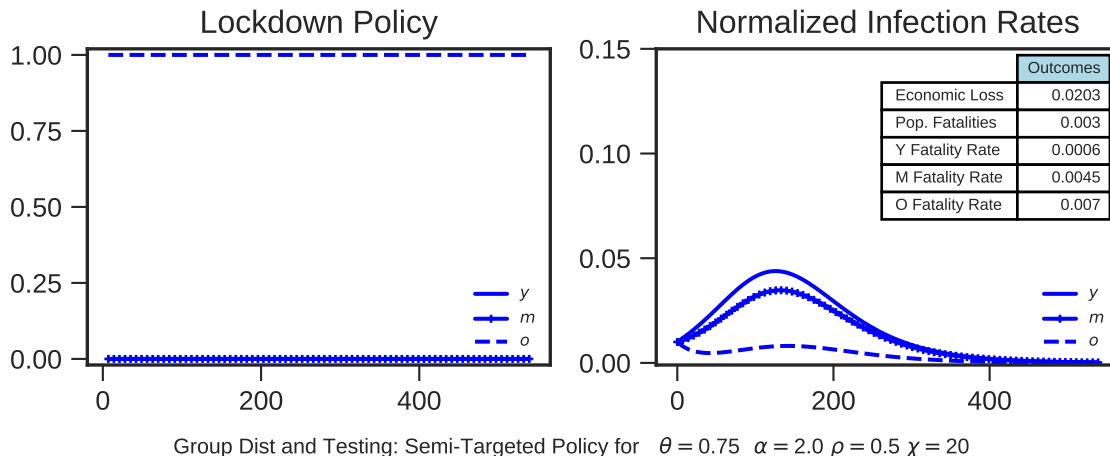

Figure 15: Optimal Semi-Targeting with group distancing and testing.

isolation probability equal to 0.4). In this case, there is no need for any lockdown for the younger groups provided that the oldest group is kept in lockdown until the arrival of the vaccine. This is sufficient to keep the overall fatality rate to 0.3% of the (adult) population and ensures a very small economic loss, equivalent to about 2% of one year’s GDP.

4.6 Other Robustness Exercises

In Table 2 we show that our broad conclusions are robust to plausible variations in other parameters. Different rows of this table consider various parameter changes relative to the baseline, with three sub-rows corresponding to each of uniform, semi-targeted and fully-targeted policies. The columns report the economic loss, fatality rate and the average level of lockdown over the pre-vaccine period for each of the three groups. In all cases, we continue to find that semi-targeting leads to substantial benefits in terms of reduced economic loss and saved lives, while the additional gains from going to full targeting are small.

The first row records our baseline case for ease of comparison. The next two report the results of lowering θ to 0.5 and those for the case where $\theta = 0.9$. Not surprisingly, lockdown is less effective the lower is θ , and losses are greater. Moreover, a lower value of θ reduces the effectiveness of targeted policies relative to optimal uniform policy. This is intuitive, since in this case the strict lockdown of the older population is not very effective, and thus there is less room for improving economic and public health outcomes by releasing the younger groups sooner.

The next row pushes the vaccine arrival out from 1.5 years to 2 years. As expected, this makes the optimal uniform policy, which in the baseline involved partially waiting for the

Parameterization	Policy Type	Econ Loss	Fatality Rate	Average Lockdown		
				Young	Middle	Old
Baseline	Uniform	0.2429	0.0183	0.2403	0.2403	0.2467
	Semi-targeted	0.1281	0.0102	0.1023	0.1023	1.0000
	Fully-targeted	0.1268	0.0100	0.0661	0.1714	1.0000
$\theta = 0.5$ (less effective lockdown)	Uniform	0.2543	0.0212	0.2357	0.2357	0.2421
	Semi-targeted	0.1871	0.0165	0.1544	0.1544	1.0000
	Fully-targeted	0.1853	0.0165	0.1221	0.2145	1.0000
$\theta = 0.9$ (more effective lockdown)	Uniform	0.2537	0.0161	0.2601	0.2601	0.2665
	Semi-targeted	0.0916	0.0064	0.0635	0.0635	1.0000
	Fully-targeted	0.0907	0.0060	0.0355	0.1256	1.0000
$T = 365 \times 2$ (two years for vaccine)	Uniform	0.2247	0.0195	0.1581	0.1581	0.1610
	Semi-targeted	0.1275	0.0102	0.0758	0.0758	1.0000
	Fully-targeted	0.1261	0.0100	0.0485	0.1276	1.0000
$\rho_o = 0.5$ (less interaction of old with others)	Uniform	0.1921	0.0139	0.1867	0.1867	0.1931
	Semi-targeted	0.1006	0.0073	0.0715	0.0715	1.0000
	Fully-targeted	0.0996	0.0070	0.0388	0.1379	1.0000
$\theta_o = 0.9$ (more effective lockdown for old)	Uniform	0.2434	0.0181	0.2420	0.2420	0.2485
	Semi-targeted	0.1256	0.0100	0.0994	0.0994	1.0000
	Fully-targeted	0.1243	0.0098	0.0636	0.1679	1.0000
$\delta_o^d = 0.12 \times \frac{1}{18}$ (doubling fatality rate for old)	Uniform	0.5145	0.0155	0.4845	0.4845	0.4909
	Semi-targeted	0.1536	0.0147	0.1437	0.1437	1.0000
	Fully-targeted	0.1529	0.0146	0.1158	0.1984	1.0000
$w_o = 0.26$ (positive cost of lockdown for old)	Uniform	0.2427	0.0190	0.2212	0.2212	0.2276
	Semi-targeted	0.1615	0.0114	0.0744	0.0744	0.6791
	Fully-targeted	0.1603	0.0112	0.0374	0.1465	0.6817
$S(0) = 0.84, I(0) = 0.01, R(0) = 0.15;$ (different initial conditions)	Uniform	0.1759	0.0148	0.1772	0.1772	0.1837
	Semi-targeted	0.0888	0.0075	0.0765	0.0765	1.0000
	Fully-targeted	0.0883	0.0073	0.0456	0.1390	1.0000

Table 2: Robustness exercises.

vaccine, less effective. Because targeted policies release the younger groups significantly before the arrival of the vaccine, this change has little impact on the form of optimal targeted policies and on the implied economic loss and fatality rates.

Next, we reduce the interaction of the old with the younger groups, ρ_o . This leads to less severe lockdowns, and lower harm. Continuing down the table, next we increase θ to 0.9, but only for the old group. This leads to almost no change from the baseline case. In the next row, we increase the mortality rate of the oldest group from the [Ferguson et al. \(2020\)](#) numbers to the higher South Korean numbers. In the optimal uniform policy, we now find much larger economic losses but far more limited increases in fatalities as the (uniform) lockdown becomes much more strict. With targeted policies, the worsening of outcomes is more evenly split between economic loss and additional fatalities.

Next, we relax the assumption that the economic contribution of the oldest group is zero. This is important for two reasons. First, as we previously noted, in the US, 20% of those above 65 work and have earnings comparable to, and in fact slightly greater than, the average for those under 65. Second, w in our model may also represent the value of consumption outside of the home, and this generates an additional social benefit from releasing the old from their lockdown. As a robustness check, we set w_o for the old to 26% of the wages of the other two groups, which is the value one gets by taking account of both the older group's somewhat higher wage and their much lower labor market participation. The form of optimal targeted policy remains similar. The older group is placed under a more strict lockdown than the other demographic groups and this lasts for much longer, about 300 days, even if not quite as long as in our baseline. It is also worth noting that the optimal targeted policy locks down the young and the middle-aged for a shorter period than in our baseline, which helps protect the older group when they are released from lockdown.

In our last exercise, we change the initial state to reflect what may be the current situation in some areas of the US with COVID-19: all three groups start with 15% of their members already recovered, 84% susceptible, and 1% infected. This leads to large reductions in both economic losses and mortality for all policies.³⁸

³⁸In results not reported in the table, we also experimented with different values of β , with proportionately higher mortality rates for all groups, and a higher mortality penalty λ for exceeding ICU capacity. None of these variations altered our main conclusions that semi-targeted policies significantly outperform uniform policies and the additional gain from fully-targeted policies relative to semi-targeted policies are small.

5 Conclusions

In this paper, we took a first step in introducing different risk groups into an otherwise standard SIR model. This generalization is important in the context of the COVID-19 pandemic, since existing evidence shows very large differences in hospitalization and fatality rates between age groups. After providing a basic analysis of the dynamics of infections in this multi-risk setting, we proceeded to a quantitative investigation of optimal policy. Optimal uniform policy, which treats different demographic groups uniformly, behaves in a similar manner in our analysis to other works in which the high mortality rates of older individuals are recognized and a relatively high value of life is used as part of the social objective. Specifically, for our baseline parameters, optimal uniform policy involves a relatively strict and long lockdown. Despite these strict lockdowns, fatalities reach 1.83% of the (adult) population and the lockdowns cost about 24.3% of one year's GDP. These significant public health and economic costs highlight the grim choices facing policymakers in the midst of the pandemic.

Our main result, however, is that better social outcomes are possible with targeted policies. Differential lockdowns on groups with differential risks can reduce both the number of lives lost and the economic damages significantly. We also find that the majority of these gains can be achieved with a simple targeted policy that applies an aggressive lockdown on the oldest group and treats the rest uniformly. These qualitative conclusions are quite consistent across different parameterizations of our model and are the main take away message from the paper. For our baseline parameterization, the optimal semi-targeted policy can reduce fatalities to 1% of the population and economic damages to 10% of one year's GDP. Alternatively, if we keep the loss of output the same as the baseline uniform policy, we can reduce the overall fatality rates to 0.71% and save approximately 2.7 million lives.

We showed that these conclusions are robust to a range of changes in parameters and the gains from targeted policies can be substantially increased if we also combine them with additional measures to reduce interactions between groups. For example, increasing the "social distance" between the oldest group and the rest of the population—by norms that temporarily reduce visits to older relatives or regulations that segregate the times when different demographic groups can go to grocery stores and pharmacies—can reduce fatalities to as little as 0.6% of the population (as compared to 1.83% in the baseline with uniform policies). Semi-targeted policies combined with identification and isolation of infected individuals can lead to even larger gains, especially when there is social distancing between groups as well, and may obviate the need to have lengthy or even any

lockdown of younger age groups.

One issue we did not address is how lockdown policies can be implemented, especially when they are heterogeneous by group and also involve various between-group social distancing elements. The “mechanism design” aspect of lockdowns is an area for future research, but here it is useful to note that semi-targeted policies may be easier to implement because the strictest lockdowns are for the older group and can be interpreted as a form of “protective custody” for that group, meaning that it is mostly to protect the group itself not to reduce the externalities they create on others. The same applies to measures to reduce interactions between this group and the rest of the population.

We view our paper as a first step in enriching the SIR model, which has become a workhorse tool for understanding and combating the COVID-19 pandemic. It is worth reiterating that many aspects of our model are highly stylized (the recovered are fully immune and do not suffer long-term health consequences; there is no endogenous social distancing; and many other relevant aspects of economic heterogeneity between sectors, occupations and skills are ignored) and there is huge uncertainty about some of the key parameters for COVID-19. The quantitative results from our analysis must therefore be taken as illustrative and interpreted with caution—and hence our greater emphasis on the qualitative patterns. There is much to be done to incorporate richer forms of economic and epidemiological interactions within and between different groups—especially to study how changes in economic and social incentives impact the dynamics of infections. We hope to be able to study some of these questions in future work.

References

Alvarez, Fernando, David Argente, and Francesco Lippi, “A Simple Planning Problem for COVID-19 Lockdown,” Working Paper 26981, National Bureau of Economic Research April 2020.

Atkeson, Andrew, “How Deadly Is COVID-19? Understanding The Difficulties With Estimation Of Its Fatality Rate,” Working Paper 26965, National Bureau of Economic Research April 2020.

—, “What Will Be the Economic Impact of COVID-19 in the US? Rough Estimates of Disease Scenarios,” Working Paper 26867, National Bureau of Economic Research March 2020.

- Avery, Christopher, William Bossert, Adam Clark, Glenn Ellison, and Sara Fisher Ellison,** “Policy Implications of Models of the Spread of Coronavirus: Perspectives and Opportunities for Economists,” Working Paper 27007, National Bureau of Economic Research April 2020.
- Bairoliya, Neha and Ayşe İmrohoroğlu,** “Macroeconomic Consequences of Stay-At-Home Policies During the COVID-19 Pandemic,” April 2020. mimeo.
- Bayham, Jude, Nicolai V. Kuminoff, Quentin Gunn, and Eli P. Fenichel,** “Measured voluntary avoidance behaviour during the 2009 A/H1N1 epidemic,” *Proceedings of the Royal Society B: Biological Sciences*, 2015, 282 (1818), 20150814.
- Berger, David W, Kyle F Herkenhoff, and Simon Mongey,** “An SEIR Infectious Disease Model with Testing and Conditional Quarantine,” Working Paper 26901, National Bureau of Economic Research March 2020.
- Blanchard, Olivier Jean and Peter A Diamond,** “The aggregate matching function,” Technical Report, National Bureau of Economic Research 1989.
- Brauer, Fred, Pauline van den Driessche, and J. Wu,** *Mathematical Epidemiology*, Springer-Verlag Berlin Heidelberg, 2008.
- Chari, V. V., Rishabh Kirpalani, and Christopher Phelan,** “The Hammer and the Scalpel: On the Economics of Indiscriminate versus Targeted Isolation Policies during Pandemics The Hammer and the Scalpel: On the Economics of Indiscriminate versus Targeted Isolation Policies during Pandemics,” 2020.
- Diamond, Peter A.,** “Aggregate Demand Management in Search Equilibrium,” *Journal of Political Economy*, 1982, 90 (5), 881–894.
- Easley, David and Jon Kleinberg,** *Networks, Crowds, and Markets: Reasoning About a Highly Connected World*, USA: Cambridge University Press, 2010.
- Eichenbaum, Martin, Sergio Rebelo, and Mathias Trabandt,** “The Macroeconomics of Epidemics,” Working Paper 26882, National Bureau of Economic Research March 2020.
- , – , and – , “The Macroeconomics of Testing During Epidemics,” April 2020. mimeo.
- Farboodi, Maryam, Gregor Jarosch, and Robert Shimer,** “Internal and External Effects of Social Distancing in a Pandemic,” Working Paper 27059, National Bureau of Economic Research April 2020.

- Favero, Carlo A., Andrea Ichino, and Aldo Rustichini**, “Restarting the Economy While Saving Lives Under COVID-19,” April 2020.
- Fenichel, Eli P**, “Economic considerations for social distancing and behavioral based policies during an epidemic.,” *J Health Econ*, Mar 2013, 32 (2), 440–451.
- Ferguson, NM, D. Laydon, G. Nedjati-Gilani, N. Imai, K Ainslie, M. Baguelin, S. Bhatta, A. Boonyasiri, Z. Cucunubá, G. Cuomo-Dannenburg, and A. Dighe**, “Impact of non-pharmaceutical interventions (NPIs) to reduce COVID-19 mortality and healthcare demand,” March 2020. Imperial College COVID-19 Response Team.
- Fernández-Villaverde, Jesús and Charles J. Jones**, “Estimating and Simulating a SIRD Model of COVID-19 for Many Countries, States, and Cities,” 2020.
- Friedman, Eric, John Friedman, Simon Johnson, and Adam Landsberg**, “Transitioning out of the Coronavirus Lockdown: A Framework for Evaluating Zone-Based Social Distancing,” 2020.
- Garibaldi, Pietro, Espen R. Moen, and Christopher A Pissarides**, “Modelling contacts and transitions in the SIR epidemics model,” in Charles Wyplosz, ed., *Covid Economics Vetted and Real-Time Papers*, CEPR, April 2020.
- Garriga, Carlos, Rody Manuelli, and Siddhartha Sanghi**, “Optimal Management of an Epidemic: An Application to COVID-19. A Progress Report,” April 2020. mimeo.
- Geoffard, Pierre-Yves and Tomas Philipson**, “Rational Epidemics and Their Public Control,” *International Economic Review*, 1996, 37 (3), 603–624.
- Glover, Andrew, Jonathan Heathcote, Dirk Krueger, and José-Víctor Ríos-Rull**, “Health versus Wealth: On the Distributional Effects of Controlling a Pandemic,” Working Paper 27046, National Bureau of Economic Research April 2020.
- Gollier, Christian**, “Cost-benefit analysis of age-specific deconfinement strategies,” April 2020. presentation slides.
- Heesterbeek, J.A.P. and M.G. Roberts**, “The type-reproduction number T in models for infectious disease control,” *Mathematical Biosciences*, 2007, 206 (1), 3 – 10. Alcala Special Issue.
- Jones, Callum J, Thomas Philippon, and Venky Venkateswaran**, “Optimal Mitigation Policies in a Pandemic: Social Distancing and Working from Home,” Working Paper 26984, National Bureau of Economic Research April 2020.

- Kermack, William Ogilvy, A. G. McKendrick, and Gilbert Thomas Walker**, "A contribution to the mathematical theory of epidemics," *Proceedings of the Royal Society of London. Series A, Containing Papers of a Mathematical and Physical Character*, 1927, 115 (772), 700–721.
- Kudlyak, Marianna, Lones Smith, and Andrea Wilson**, "Avoidance Behavior at the COVID19 Breakout in an SI3R Model," April 2020. mimeo.
- Lehman, Clarence, Shelby Loberg, and Adam Clark**, *Quantitative Ecology: A New Unified Approach*, University of Minnesota Libraries Publishing, 2019.
- Manski, Charles F and Francesca Molinari**, "Estimating the COVID-19 Infection Rate: Anatomy of an Inference Problem," Working Paper 27023, National Bureau of Economic Research April 2020.
- McCallum, Hamish, Nigel Barlow, and Jim Hone**, "How should pathogen transmission be modelled?," *Trends in Ecology and Evolution*, 2001, 16 (6), 295 – 300.
- Pissarides, Christopher**, "Unemployment and vacancies in Britain," *Economic policy*, 1986, 1 (3), 499–541.
- Rampini, Adriano A**, "Sequential Lifting of COVID-19 Interventions with Population Heterogeneity," Working Paper 27063, National Bureau of Economic Research April 2020.
- Rowthorn, Robert and Flavio Toxvaerd**, "The Optimal Control of Infectious Diseases via Prevention and Treatment," Technical Report 2013, Cambridge-INET Working Paper 2020.
- Stock, James H**, "Data Gaps and the Policy Response to the Novel Coronavirus," Working Paper 26902, National Bureau of Economic Research March 2020.